



NEW GLOBAL STANDARD
VERTICAL MACHINING CENTER

DNM

4500 • 5700 • 6700

4th Generation



DN SOLUTIONS

NEW DNM series 4th Generation

4500 · 5700 · 6700

DNM, which is used by many customers around the world, inherited the reputation of the first, second, and third generations and improved reliability in the '4th DNM', and applied grease lubrication to the spindle and each axis system as standard for eco-friendly operation. In particular, it was developed with the goal of outstanding productivity, best-in-class durability and rigidity, and enhanced user convenience.



The 4th generation DNM is equipped with the maximum machining area, superior rapid performance, and productivity compared to competitors, ensuring precise and efficient machining. Additionally, it offers various options and convenient features, including a 15-inch touch screen.



A HIGHLY VERSATILE VERTICAL MACHINING CENTER WITH THE LARGEST MACHINING ENVELOPE IN ITS CLASS

- GDNM is a Global Standard 3-axis Machining Center that has improved rapid and acceleration/deceleration performance, and has the highest productivity compared to competitors.
- Compared to the previous model, various options are provided and user convenience is increased through EZ Work improvement.

STANDARD DIRECT-COUPLED SPINDLE FOR HIGHER PRODUCTIVITY

- Improved axial thermal displacement by 2x compared to previous models, and ATC Shutter as standard to prevent chip penetration into the ATC.
- High-torque and high speed spindles are available for the machining of different materials.
- Higher productivity is achieved by reducing tool change times and by improving acceleration and deceleration rates.

AN ENVIRONMENTALLY-FRIENDLY MACHINE DESIGNED FOR STABLE AND EASY OPERATION

- Thermal error compensation system supplied as standard optimizes machine accuracy by reducing the effects of heat build-up during extended periods of operation.
- A 15-inch iHMI touch screen is standard for easy machine operation, and a variety of convenience features are available.
- Grease lubrication for the axis roller guideways is a standard feature and helps reduce contamination.

BASIC STRUCTURE

Designed with a highly stable and rigid structure, the new DNM series provides customers with machines with different Y-axis capabilities (from 450mm to 670mm), enabling the machining of a wider range of workpieces.

Travel distance (X / Y / Z axis)

DNM 4500

800 / 450 / 510 mm
31.5 / 17.7 / 20.1 inch

DNM 5700

1050 / 570 / 510 mm
41.3 / 22.4 / 20.1 inch

DNM 6700

1300 / 670 / 625 mm
51.2 / 26.4 / 24.6 inch

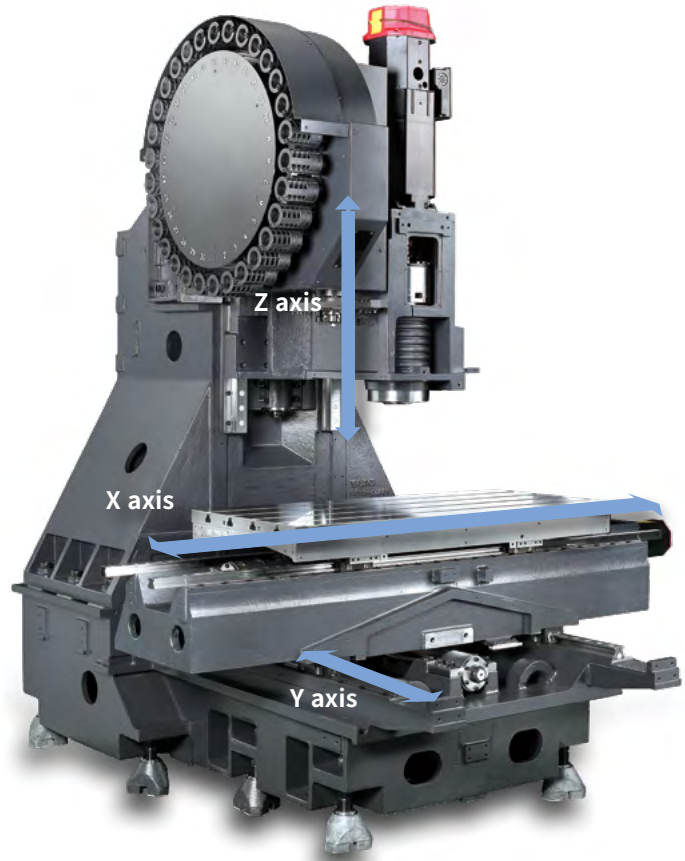

DNM 6700

Axis system

Environmentally-friendly grease lubrication is adopted as standard for all the axis feed systems, and roller-type LM guides are used to enhance rigidity.

Rapid traverse rate (X / Y / Z axis)

DNM 4500 / 5700

42 / 42 / 36 m/min
1653.5 / 1653.5 / 1417.3 ipm

DNM 6700

36 / 36 / 30 m/min
1417.3 / 1417.3 / 1181.1 ipm

Roller-type LM Guides are provided as a standard feature.



Grease lubrication for all axes is a standard feature.

SPINDLE | TABLE

Directly-coupled spindles have been adopted as a standard feature to further reduce vibration and noise and enhance productivity, increase accuracy and improve the working environment. High-torque and high speed spindle options for machining different materials are available.

Max. spindle speed

8000 r/min
{12000 / 15000} r/min option

Max. spindle motor power

18.5 kW 24.8 Hp

Max. spindle motor torque

117.8 N·m 86.9 lbf-ft
(8000 r/min, 12000 r/min,
15000 r/min)

286 N·m 211.1 lbf-ft option
(8000 r/min high torque version)

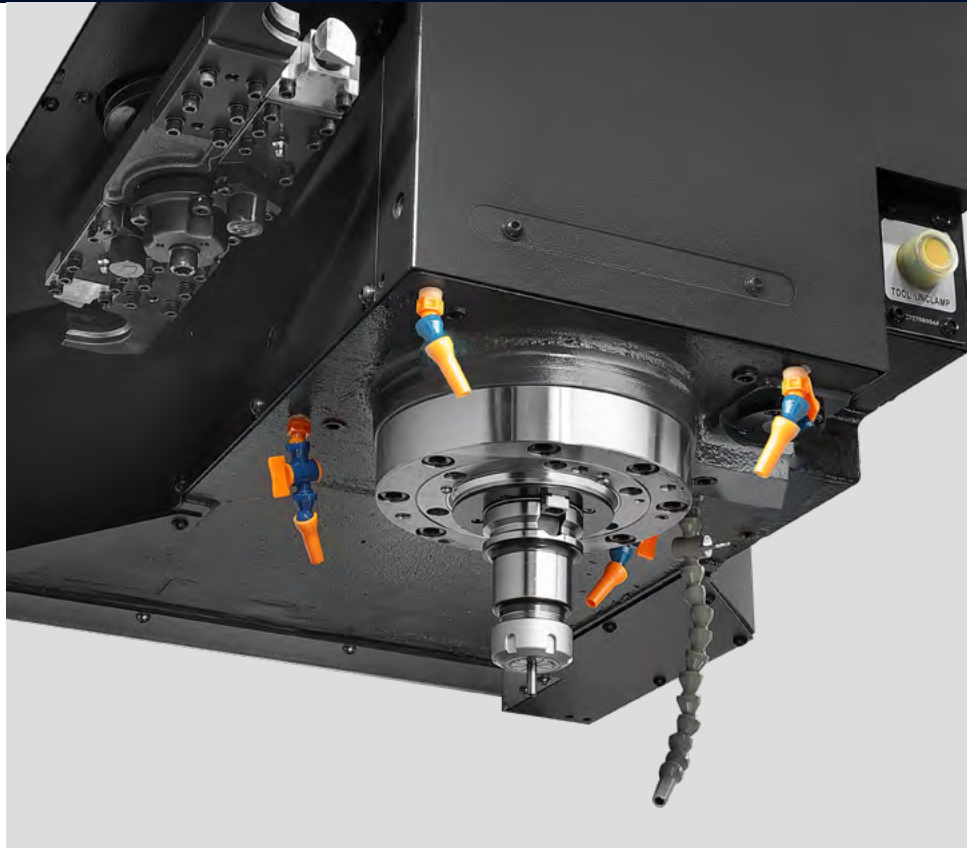

TABLE

Increased table sizes and table load capacities are provided within the same floor space of the previous models.

Table size (A x B)

DNM 4500

1000 x **450** mm
39.4 x 17.7 inch

DNM 5700

1300 x **570** mm
51.2 x 21.3 inch

DNM 6700

1500 x **670** mm
59.1 x 26.4 inch

Max weight on Table

DNM 4500 / 5700 / 6700

600 / 1000 / 1300 kg
1322.8 / 2204.6 / 2866.0 lb

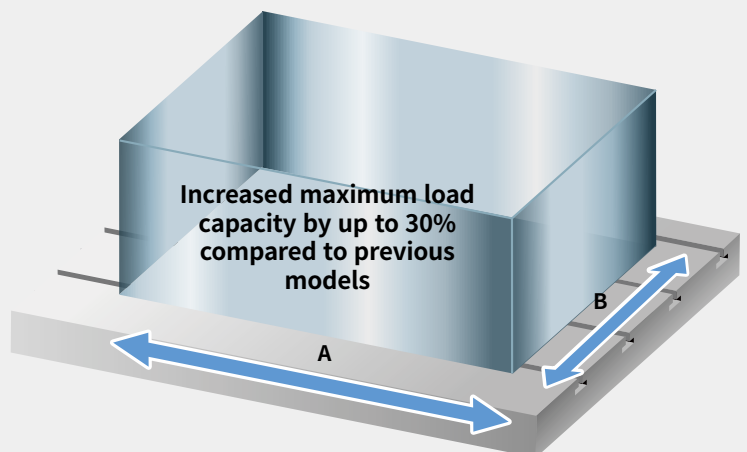

TOOL CHANGE SYSTEM

Tool changers have been optimized to reduce non cutting times. The highly-reliable tool magazine can accommodate up to 30 tools as standard.



Tool to Tool time

1.2 S

Chip to Chip* time

4.1 S (with ATC Shutter)

3.2 S (w/o ATC Shutter)

* The Chip-to-Chip time has been tested in accordance with DN Solutions's strict testing procedures, but may vary depending on the user's operating conditions.

Tool storage capacity

30 {40 / 60} ea option

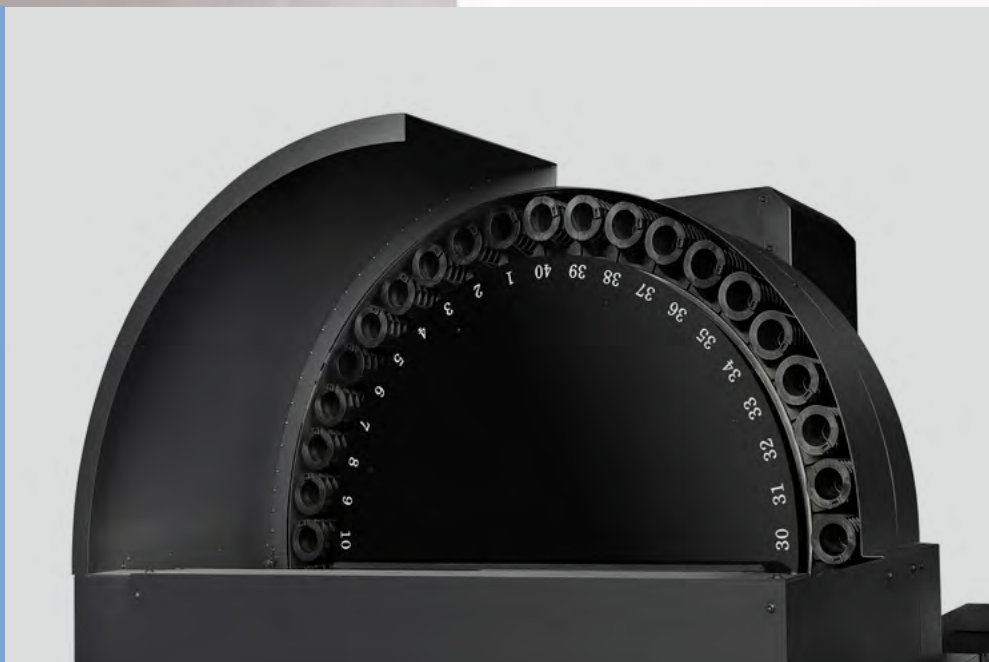

NEW 4th GENERATION DNM¹ ENHANCEMENTS

DNM, the global standard 3-axis machining center, is a best-selling model that has increased user convenience and enhanced product performance and design. Introducing the strengths of the 4th generation DNM.

Improved axis thermal displacement

X, Y : **2** x improvement Z : **1.3** x improvement

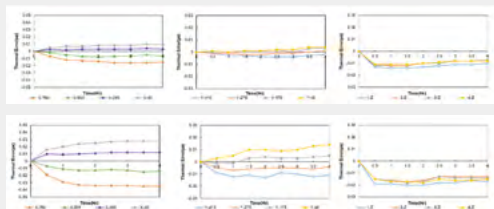

* The above test results are based on our test standards and may vary depending on conditions (DNM 4500)

Coolant tank capacity 20% up

Improved to reduce coolant shortage, replenishment cycle when using multiple coolant systems simultaneously.

DNM4500 : 300 → **380L**

DNM5700 : 345 → **430L**

DNM6700 : 390 → **485L**

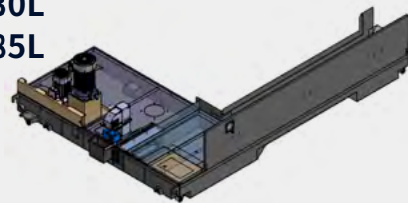

Applying the Atc shutter standard

Prevent chip penetration into the ATC.

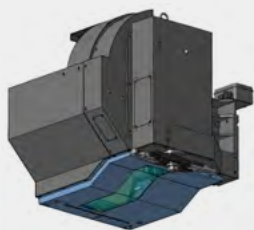

EZ Work

Upgraded the design of the EZ WORK main screen by adding bookmarks and operation buttons.



C/C speed adjustment and 20% more chip ejection space

Adjusting C/C speed by applying an inverter

20% increase in CHIP exhaust space (Easier to eject large chips)

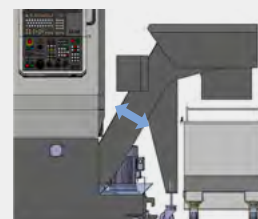

160(6.3) → **200mm** (7.9 inch)

Round Type Flood Coolant

Expect better machining performance and longer tool life

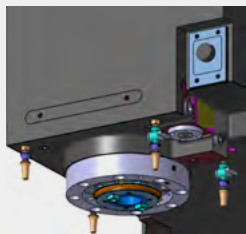

Tool call function

A function that directly exchanges the tool to the spindle when the user inputs the desired tool number or magazine port number and calls the tool.

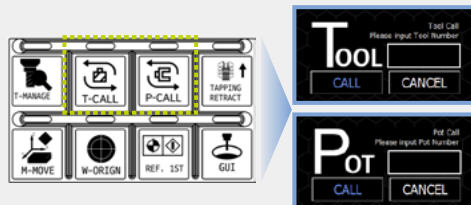

Rear Tool Storage Options option

- (W/Tool Info Touch Screen)
- Applying a large door that is advantageous for tool storage
- Tool information touch screen

Tool Information Input

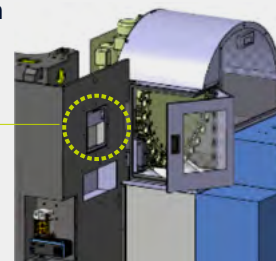

High Productivity

Rapid

· DNM4500 / DNM5700

X/Y/Z : 36/36/30 → **42/42/36** m/min
1653.5 / 1653.5 / 1417.3 ipm

· DNM6700 X/Y/Z : 36/36/30 m/min

1417.3 / 1417.3 / 1181.1 ipm

Productivity : In DNM4500

	Non-cutting time	Cutting time	Run hours
Previous model	1min 47sec.	1min 22sec.	3min. 9sec.
New DNM series	Reduced by 13.1 %		Reduced by 7.3 %
	1min 33sec.	1min 22sec.	2min. 55sec.

* The results, indicated in this catalogue, are provided as examples only. They may not always be achieved owing to different cutting and environmental conditions.

Power consumption monitoring function

- Suitable for power consumption management with standard power consumption monitoring function.



High efficiency coolant pump

- FLOOD : 1.8 → 1.1kW / 1.1 → 0.75kW
- Performance is maintained and energy consumption is reduced by using a high-efficiency motor.

Productivity UP

- Productivity improvement reduces processing time for the same item and energy consumption compared to competitors.

Chip conveyor with inverter

- Energy saving by optimizing the rotation speed according to the amount of chips.



GREASE lubrication

- Optimization of oil usage by applying grease lubrication.



MACHINING PERFORMANCE

The DNM series delivers the best cutting performance in its class and ensures highest levels of productivity.

Cutting performance

High-rigidity machining can be undertaken with speed and precision.

*The results, indicated in this catalogue, are provided as examples only. They may not always be achieved owing to different cutting and environmental conditions.

Face mill (ø80mm (3.15 inch)) Carbon steel (SM45C)			
Chip removal rate cm ³ /min (inch ³ /min)	Spindle speed r/min	Feedrate mm/min (ipm)	
527 (32.2)	1500	2700 (106.3)	
Face mill (ø80mm (3.15 inch)) Aluminium(AL6061)			
Chip removal rate cm ³ /min (inch ³ /min)	Spindle speed r/min	Feedrate mm/min (ipm)	
1901 (116.0)	1500	5940 (233.9)	
End mill (ø30mm (i.2 inch)) Carbon steel (SM45C)			
Chip removal rate cm ³ /min (inch ³ /min)	Spindle speed r/min	Feedrate mm/min (ipm)	
48 (2.9)	222	107 (4.2)	
U-Drill (ø50mm (2.0 inch)) Carbon steel (SM45C)			
Chip removal rate cm ³ /min (inch ³ /min)	Spindle speed r/min	Feedrate mm/min (ipm)	
501 (30.6)	1500	255 (10.0)	
Tap Carbon steel (SM45C)			
Tap size mm	Spindle speed r/min	Feedrate mm/min (ipm)	
M 36 x P 4.0	221	884 (34.8)	

AWC, Multi-AWC

A compact loading/unloading automation capable of mounting up to 40 workpieces.

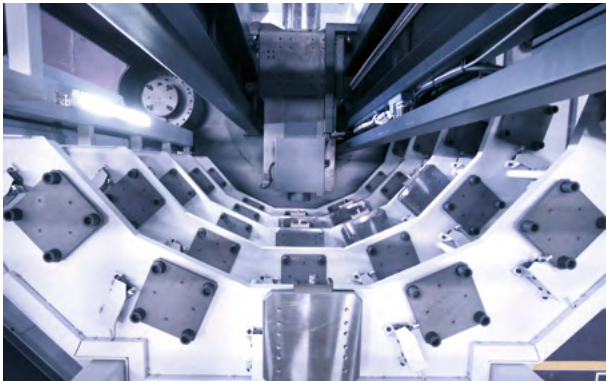
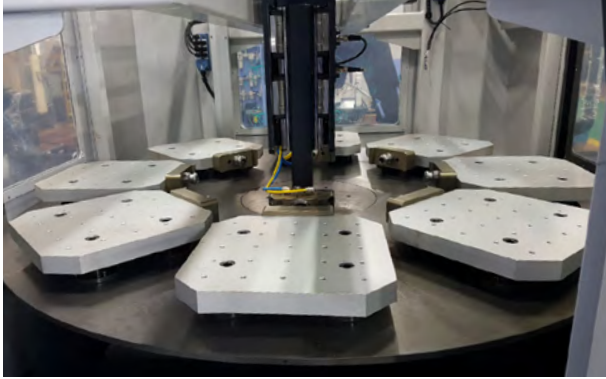

AWC option

A compact automation system providing fast, reliable and high productivity workpiece change capabilities.



Multi-AWC option

Automation solution capable of mounting up to 40 workpieces.

Description	Pallet size	No. of pallets	Max. workpiece dia. x height	Max. workpiece weight
AWC	250x250 mm (9.8x9.8 inch)	12ea	Ø300x350 mm (11.8x13.8 inch)	130 kg (286.6 lb)
	350x350 mm (13.8x13.8 inch)	8ea	Ø400x350 mm (15.7x13.8 inch)	250 kg (551.1 lb)
	400x400mm (15.7x15.7 inch)	6ea	Ø450x350 mm (17.7x13.8 inch)	250 kg (551.1 lb)
	500x500mm (19.7x19.7 inch)	4ea	Ø550x350 mm (21.7x13.8 inch)	250 kg (551.1 lb)
Multi-AWC	250x250mm (9.8x9.8 inch)	40ea (10x4-tier)	Ø300x350 mm (11.8x13.8 inch)	65kg, 130kg <small>option</small> (143.3, 286.6 lb)
	350x350mm (13.8x13.8 inch)	32ea (8x4-tier)	Ø400x350 mm (15.7x13.8 inch)	250 kg (551.1 lb)
	400x400mm (15.7x15.7 inch)	6ea	Ø450x350 mm (17.7x13.8 inch)	250 kg (551.1 lb)
	500x500mm (19.7x19.7 inch)	24ea	Ø550x350 mm (21.7x13.8 inch)	250 kg (551.1 lb)

Pallet storage-table configuration

unit : mm (inch)

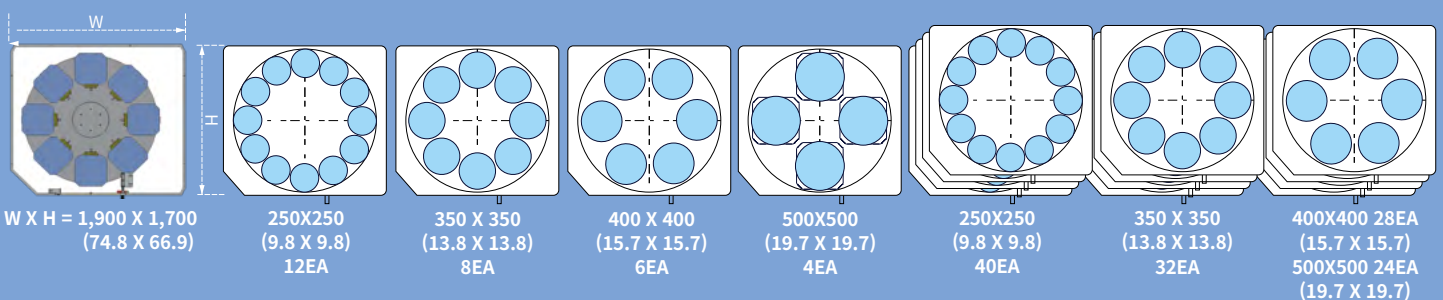

STANDARD | OPTIONAL SPECIFICATIONS

Various optional features are available to meet customers' specific machining requirements and applications.

Description	Features		DNM 4500	DNM 5700	DNM 6700	
Spindle	8000 r/min	18.5/11 kW, 117.8 N·m	●	●	X	
		18.5/15 kW, 117.8 N·m	X	X	●	
		15/11 kW, 286 N·m	○	○	○	
	12000 r/min	18.5/11 kW, 117.8 N·m	○	○	○	
	15000 r/min	18.5/11 kW, 117.8 N·m	○	○	○	
Magazine	Tool storage capacity	30 ea	●	●	●	
		40 ea	○	○	○	
Tool shank type		BIG PLUS BT40	●	●	●	
		BIG PLUS CAT40	○	○	○	
		BIG PLUS DIN40	○	○	○	
Raised column		150 mm	○	○	○	
		200 mm	○	○	○	
		300 mm	○	○	○	
4 axis NC Rotary table		S-200F4-DS	○	○	○	
		S-250F8-DS	○	○	○	
		S-320F8-DS	X/○	○	○	
Coolant	FLOOD	0.19 MPa (0.4 kW)	●	●	●	
		0.45 MPa (0.75 kW)	○	○	○	
		0.69 MPa (1.1 kW)	○	○	○	
	TSC**	None	●	●	●	
		2 MPa (1.5kW)	○	○	○	
		2 MPa (4 kW)	○	○	○	
		3 MPa (2.9 kW)	○	○	○	
		7 MPa (7.5 kW)	○	○	○	
		TOP FLUSHING	○	○	○	
	SHOWER (200 L/min)		○	○	○	
		○	○	○		
Chip disposal	Chip conveyor	Chip pan	●	●	●	
		Hinged type (Left/Right/Rear)	○	○	○	
		Magnetic scraper type (Left/Right/Rear)	○	○	○	
		Screw(AUGER) type (Left/Right)	○	○	○	
		DRUM type (Right)	○	○	○	
Chip bucket		○	○	○		
Precision machining option		Linear scale X / Y / Zaxis	○	○	○	
		AICC II (200 block)	●	●	●	
		SSP (Smooth Surface Package)	○	○	○	
Measurement & Automation	Automatic tool measurement	TS27R_RENISHAW	○	○	○	
		OTS_RENISHAW	○	○	○	
	Automatic tool breakage detection		○	○	○	
	Automatic workpiece measurement	OMP60_RENISHAW	○	○	○	
Automatic front door with safety device		○	○	○		
Accessories	WORK LIGHT	LED LAMP	●	●	●	
	OPERATOR CALL LAMP	3-COLOR SIGNAL TOWER(LED)	●	●	●	
	LEVELING BLOCK & BOLT	-	●	●	●	
	SMART THERMAL CONTROL	SENSORLESS TYPE(ONLY SPINDLE)	●	●	●	
	ASSEMBLY & OPERATION TOOLS KIT	-	●	●	●	
	4TH AXIS PREPARATION CABLING FOR SERVO/1-PNEUMATIC PIPING	FACTORY READY MADE	○	○	○	
	AIR GUN		○	○	○	
	Air blower		○	○	○	
	Coolant gun		○	○	○	
	Mist collector		○	○	○	
Customized Special Option	ANCHORING (1)	SLIDE CLAMP & CHEMICAL ANCHOR BOLT	○	○	○	
		TSA (2)	0.54	○	○	
	TOOL TYPE	HSK63A	○	○	○	
	ATC	60T	○	○	○	
	Drum chipconveyor (Rear type)	HINGE TYPE	○	○	○	
		SCRAPER TYPE	○	○	○	
	20 Bar TSC with inverter	50Hz → 60Hz	○	○	○	
	FINE DUST PROTECTING PACKAGE	WET MACHINING	BELLOWS COVER(X/Y/Z)	○	○	○
			PROTECT COVER(X-AXIS)	○	○	○
			BALL SCREW BELLOWS COVER(X/Y)	○	○	○
			GUIDE WAY DOUBLE WIPER	○	○	○
		DRY MACHINING	PROTECT COVER(X-AXIS)	○	○	○
			BALL SCREW BELLOWS COVER(X/Y)	○	○	○
			GUIDE WAY DOUBLE WIPER	○	○	○
			AIR OIL SUCTION(ONLY 15k SPINDLE)	○	○	○
	AUTO TOOL LENGTH MEASUREMENT	RENISHAW / LTS	○	○	○	
	AUTO TOOL BREAKAGE DETECTION	MSC/BK9(NEEDLE TYPE ON MAGAZINE)	○	○	○	

* Please contact DN Solutions for detailed specification information.

** If this option is selected, the TSA(Through Spindle Air) Max.pressure is 0.54MP

* When using a semi-synthetic type or synthetic type, contact our sales representative or service center in advance.

(1) Please refer to foundation drawing in relation to anchoring. If more detailed information is required consult with DN Solutions service

(2) If TSC is not required - TSA can be selected as an option.

● Standard ○ Optional X Not applicable

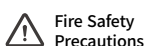

There is a high risk of fire when using non-water-soluble cutting fluids, processing flammable materials, neglecting the controlled and careful use of coolants and modifying the machine without the consent of the manufacturer. Always check the SAFETY GUIDELINES carefully before using the machine.

PERIPHERAL EQUIPMENT

Grease lubrication system

The standard grease lubrication system eliminates the need for an oil skimmer and reduces lubrication costs by about 60% compared to oil lubrication.

Yearly maintenance cost

Reduced by
Max. **60%**



Raised column option

When the distance between the table and the spindle nose needs to be extended, for example, to accommodate a fixture or a rotary table, the solid one-piece raised column can be raised to increase the distance required.

Height
150/200/300 mm
5.9/7.9/11.8 inch

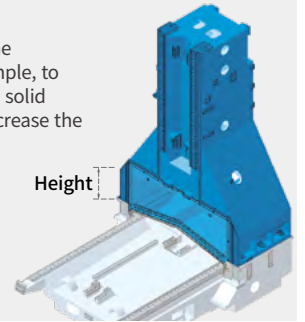

Chip conveyor option

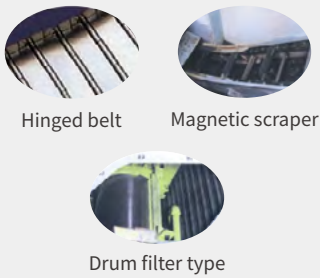

Screw (Auger) type

Programmable flood coolant option

Option to increase tool life and increase user convenience by automatically adjusting the nozzle angle according to the specified tool length and spraying reciprocally.



Chip conveyor type	Material	Description
Hinged belt	Steel	Hinged belt chip conveyor, which is most commonly used for steel work [for cleaning chips longer than 30mm (1.2inch)], is available as an option.
Magnetic scraper	Cast Iron	Magnetic scraper type chip conveyor, which is ideal for die-casting work [for cleaning small chips], is available as an option.
Screw (Auger) type	Steel	Screw (Auger) type chip conveyor is suitable for minimizing installation space. About 85% floor space is required to install Screw (Auger) type chip conveyor compared to Hinged belt type.
Drum filter type	Aluminium	Drum filter type chip conveyor, which is ideal for aluminium work [for filtering small chips], is available as an option.

Chip bucket option

Capacity
300 L
79.3 gal



Hydraulic / Pneumatic fixture line option

The user should prepare pipelines for hydraulic/pneumatic fixtures whose detailed specifications should be determined through discussions with DN Solutions.

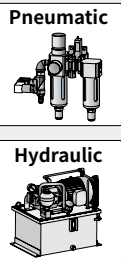
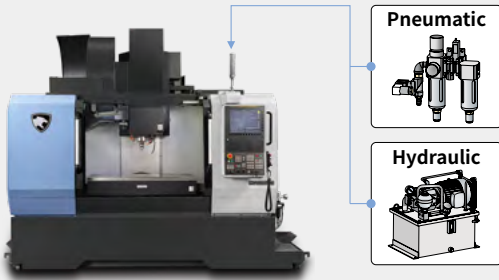

4 axis rotary table option

The high-precision split system with its compact and highly rigid design, and double piston structure enables vertical and horizontal use and delivers a strong clamping force.



OP height adjustment function option

3 Steps at 40mm intervals
(Upper 2 steps & Lower 1 step)

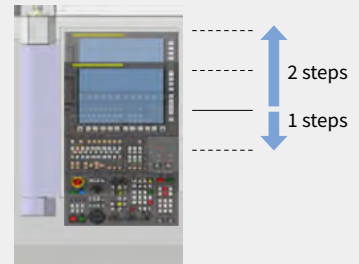

AWC system option

A compact automatic workpiece change system



Max. workpiece dimensions	Unit	Count	Max. loading	Max. construction height on the pallet
250 x 250 (9.8x9.8) or ø 300 (11.8)	mm (inch)	12	130kg (286.6lb)	350mm (13.8inch)
320 x 320 (12.6x12.6) or ø 360 (14.2)	mm (inch)	10	250kg (551.1lb)	
350 x 350 (13.8x13.8) or ø 400 (15.7)	mm (inch)	8		
400 x 400 (15.7x15.7) or ø 450 (17.7)	mm (inch)	6		
500 x 500 (19.7x19.7) or ø 550 (21.7)	mm (inch)	4		

Pallet Storage-Table Configuration

Unit : mm (inch)

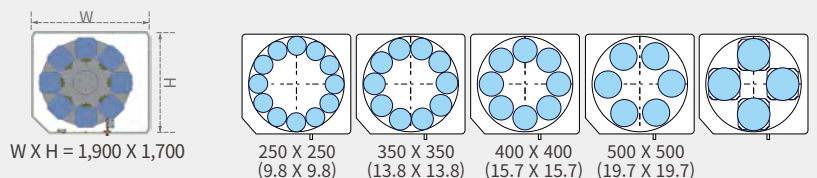

DN SOLUTIONS FANUC i PLUS

DN Solutions Fanuc i Plus is optimized for maximizing customer productivity and convenience.

15 inch screen + new operation panel

DN Solutions Fanuc i Plus' operation panel enhances operating convenience by incorporating common-design buttons and layout, and features the Qwerty keyboard for fast and easy operation.

DN Solutions Fanuc i Plus

- 15 inch color display
- Intuitive and user-friendly design

USB & PCMCIA card

QWERTY keyboard

- EZ-guide i standard
- Ergonomic operator panel
- 2MB Memory
- Hot key



iHMI touchscreen option

iHMI provides an intuitive interface that uses a touchscreen for quick and easy operation.

Range of applications

Providing various applications related to planning, machining, improvement and utility, for customer convenience.

NUMERIC CONTROL SPECIFICATIONS

FANUC

Item	Specifications	DN Solutions Fanuc i (0i Plus)
Controlled axis	Controlled axes	3 (X,Y,Z)
	Simultaneously controlled axes	4 axes
	Additional controlled Axis	●
Data input/output	Fast data server	○
	Memory card input/output	●
	USB memory input/output	●
	Large capacity memory(2GB)*2	○
Interface function	Embedded Ethernet	●
	Fast Ethernet	○
	Enhanced Embedded Ethernet function	●
Operation	DNC operation	Included in RS232C interface. ●
	DNC operation with memory card	●
Program input	Workpiece coordinate system	G52 - G59 ●
	Addition of workpiece coordinate system	G54.1 P1 X 48 (48 pairs) ●
	Tool number command	T4 digits
	Tilted working plane indexing command	G68.2 TWP ○
Feed function	AI contour control I	G5.1 Q_, 40 Blocks X
	AI contour control II	G5.1 Q_, 200 Blocks ●
	AI contour control II	G5.1 Q_, 400 Blocks ○
	AI contour control II	G5.1 Q_, 600 Blocks X
	AI contour control II	G5.1 Q_, 1000 Blocks *1) X
	High smooth TCP	X
Operation guidance function	EZ Guidei (Conversational Programming Solution)	●
	EZ Operation package	●
Setting and display	CNC screen dual display function	●
Network	FANUC MTConnect	⊕
	FANUC OPC UA	⊕
Others	Display unit	10.4" color LCD X
		15" color LCD X
		15" color LCD with Touch Panel ●
	Part program storage size & Number of registerable programs	640M(256KB)_500 programs X
		1280M(512KB)_1000 programs X
		2560M(1MB)_1000 programs X
		5120M(2MB)_1000 programs ●
		10240M(4MB)_1000 programs X
		20480M(8MB)_1000 programs X
		2560M(1MB)_2000 programs X
		5120M(2MB)_4000 programs X
		10240M(4MB)_4000 programs X
		20480M(8MB)_4000 programs X

*1) The number of look-ahead blocks may be changed or limited depending on the peripheral device or the configuration of the internal NC system.

● Standard ○ Optional X N/A ⊕ Available
Network: FANUC MT Connect and FANUC OPC UA available.

EZ WORK

The software developed by DN Solutions provides a range of different functions designed for fast, efficient and convenient operation.

EZ work

The EZ work package delivers speed and efficiency. This menu-driven innovation not only helps customers reduce setup times, but also simplifies common tasks and procedures, reducing the potential for errors. EZ work reduces operating time, protects machinery, enhances quality and speeds up maintenance interventions.



Thermal Compensation

A function to maintain high-precision machining quality by analyzing and correcting the amount of thermal displacement of a structure through a temperature sensor



M/G-Code List

Functional description of M code and G code



Tool Management

Function to manage tool information [Tool information / Tool No. / Tool condition (normal, large diameter, worn / damaged, used for the rst time, manual) / Tool name]

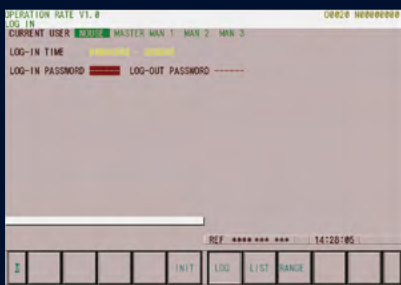

Operation Rate

Machine operation history management function by date based on load



Adaptive Feed Control

Function to control feedrate so that the cutting can be carried out at a constant load (To adapt to the spindle load set up with constant load feedrate control function)

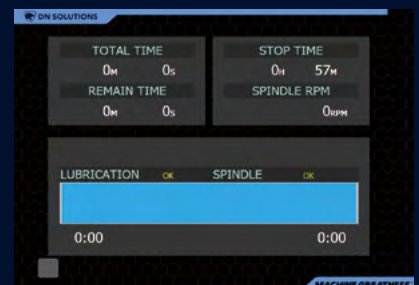

Spindle Warm Up

A function that assists spindle warm-up for spindle life when the spindle has not been used for a certain period of time



ATC Recovery

Function to view detailed info with recommended actions and to perform step-by-step operation manually (when an alarm is triggered during an ATC operation)



Addition of Optional Block Skip

In addition to the OPTIONAL BLOCK SKIP of the operation panel, the function to skip a specific block selected in the machining program



PFC (Programmable Flood Coolant)

Function to automatically adjust the nozzle angle according to the specified tool length.

CONVENIENT OPERATION

HEIDENHAIN TNC620

Superior hardware specifications

The TNC 620 features optimized motion control, short block processing times and special control strategies. Together with its uniform digital design and its integrated digital drive control (including inverters), it enables you to achieve high machining speeds and the best possible contour accuracy.

- 15.6" display
- 21GB Storage memory
- 1024 look ahead blocks
- High user convenience with folder structure data management



Conversational convenient function

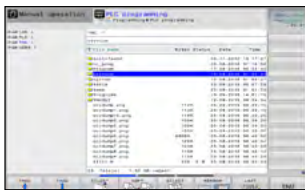

Data are controlled in the folder structure; convenient communication via USB devices



KinematicOpt & KinematicComp option
(Touch probe cycle for automatic measurement)

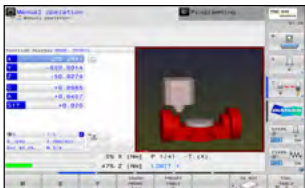

Collision protection system option



Adaptive feed control option

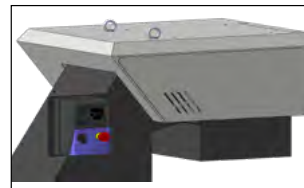

Various built-in pattern cycles for a wider scope of application (Software standard)

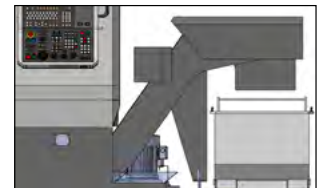

Graphic simulation

NUMERIC CONTROL SPECIFICATIONS



HEIDENHAIN

Item		Specifications	TNC620 DNM
Controlled axis	Controlled axis		3 (X,Y,Z)
	Simultaneously controlled axis		4 axis
Data input/output	USB memory input/output		●
Interface function	Embedded ethernet		●
Feed function	Look-ahead	5000 blocks	●
Axis compensation	KinematicsOpt	Automatic measurement and optimization of machine kinematics	○
Collision monitoring	Dynamic collision monitoring (DCM)		X
Network	MTConnect		⊕
Others	Display unit	15" color LCD	●
		15" color LCD with touch panel	○
	Part program storage size & number of registerable programs	1.8GB	●

● Standard ○ Optional X Not Available ⊕ Available

CONVENIENT OPERATION

SIEMENS 828D

15.6" screen + new operation panel

The newly-designed operation panel improves the customer convenience by incorporating and using common-design buttons and layouts, and includes the familiar QWERTY keyboard for fast and easy operation.

- 15.6" display
- 10MB high capacity user memory
- USB & ethernet (standard)
- QWERTY keyboard (standard)
- High-speed calculation and simulation can be fulfilled by improved processor functionality



Conversational convenient function

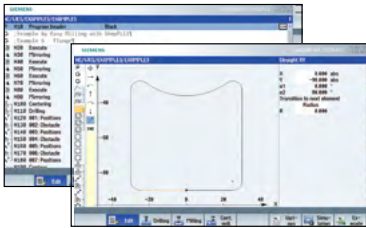

Shop Mill Part Programming

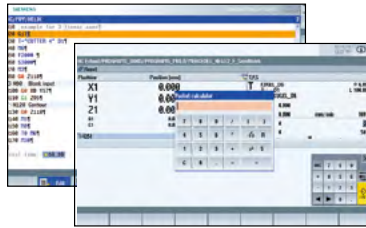

Smart function

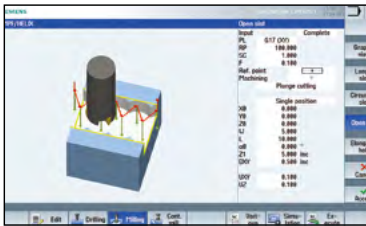

Advanced program language programGUIDE

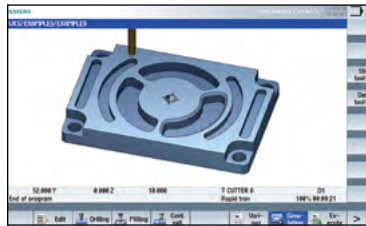

Simulation and machining contour monitoring

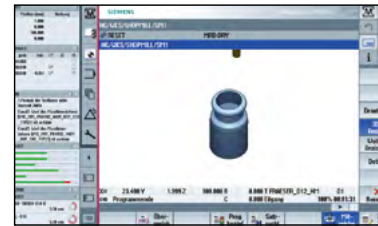

Side screen widget

NUMERIC CONTROL SPECIFICATIONS

SIEMENS

	Item	Specifications	S828D
			DNM
Controlled axis	Controlled axes (제어축수)	-	3축
	Simultaneously controlled axes (동시 제어축수)	-	3축
Data input/output	Memory card input/output	(Local drive)	X
	USB memory input/output		●
Interface function	Ethernet	(X130)	●
Operation	On network drive	(without EES option, Extcall)	○
	On USB storage medium, e.g. memory stick	(without EES option, Extcall)	●
Program input	Workpiece coordinate system	G54 - G57	●
	Addition of workpiece coordinate system	G505 - G599	●
Interpolation & Feed function	Advanced surface		●
	Top surface		○
Programming & Editing function	Look ahead number of block	S/W version 4.8	450
	3D simulation, finished part		●
Operation Guidance Function	Simultaneous recording		●
	Measure kinematics		X
Setting and display	DXF Reader for PC integrated in SINUMERIK Operate		○
	ShopMill		●
Network	EZ Work		●
	Operation via a VNC viewer		●
Etc. function	MTCConnect		⊕
	OPCUA		○
Etc. function	15.6" color display with touch screen		●
	19" color display without touch screen		X
	21.5" color display with touch screen		X
	CNC user memory	10 MB	●
	Expansion by increments	2 ~ 12 MB	○
Etc. function	Collision avoidance		X
	Collision avoidance ECO (machine, working area)		X

POWER | TORQUE

FANUC

DNM 4500 / 5700

8000 r/min

Max. spindle power: 18.5 kW (24.8 Hp)

Max. spindle torque: 117.8 N·m (86.9 lbf-ft)

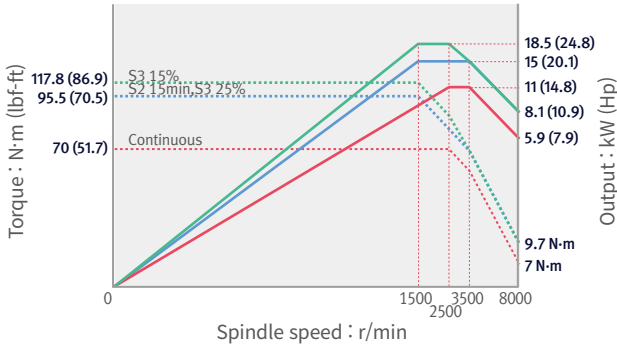

8000 r/min **option**

Max. spindle power: 15 kW (20.1 Hp)

Max. spindle torque: 286 N·m (211.1 lbf-ft)

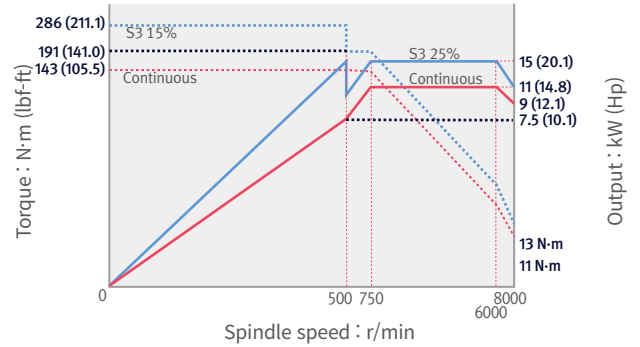

DNM 6700

8000 r/min

Max. spindle power: 18.5 kW (24.8 Hp)

Max. spindle torque: 117.8 N·m (86.9 lbf-ft)

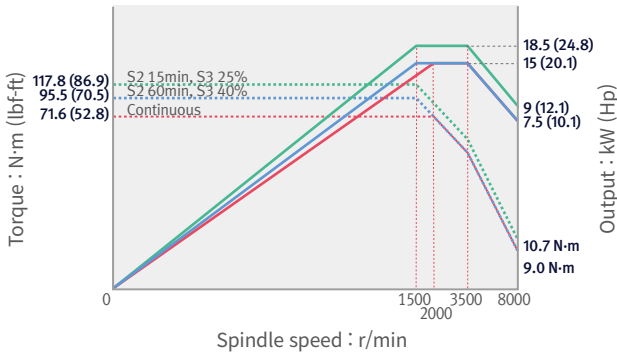

8000 r/min **option**

Max. spindle power: 15 kW (20.1 Hp)

Max. spindle torque: 286 N·m (211.1 lbf-ft)

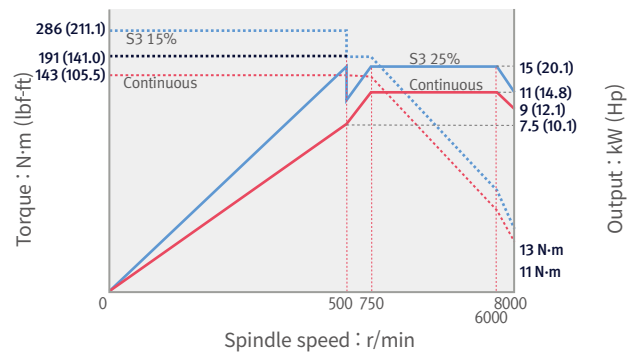

DNM 4500 / 5700 / 6700

12000 r/min **option**

Max. spindle power: 18.5 kW (24.8 Hp)

Max. spindle torque: 117.8 N·m (86.9 lbf-ft)

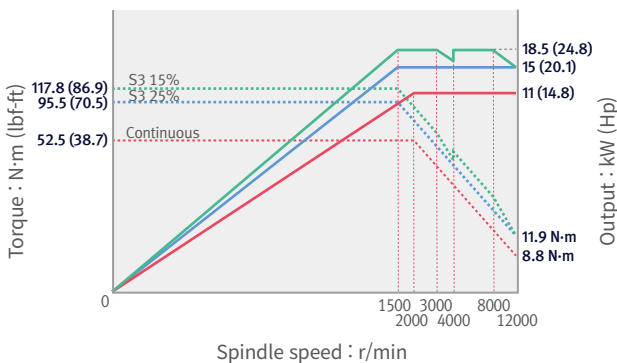

15000 r/min **option**

Max. spindle power: 18.5 kW (24.8 Hp)

Max. spindle torque: 117.8 N·m (86.9 lbf-ft)

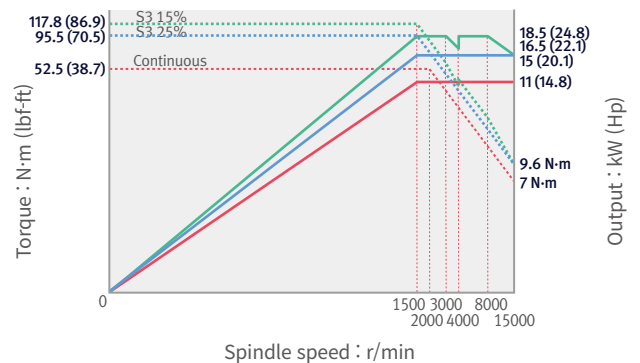

POWER | TORQUE

SIEMENS

DNM 4500 / 5700

12000 r/min

Max. spindle power: 16.5 kW (22.1 Hp)

Max. spindle torque: 141.3 N·m (104.3 lbf-ft)

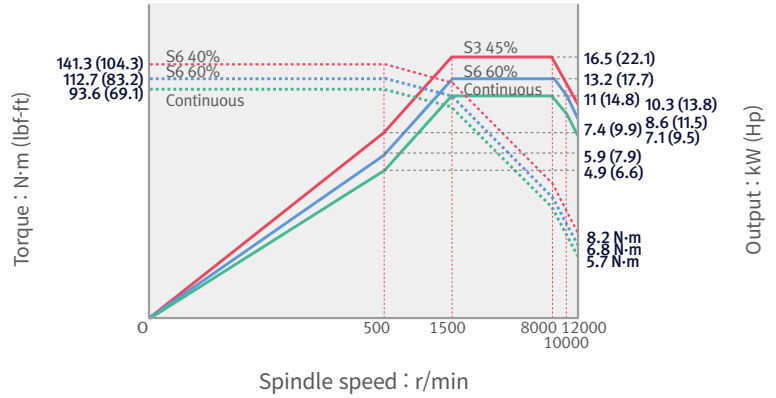

DNM 6700

12000 r/min

Max. spindle power: 21.8 kW (29.2 Hp)

Max. spindle torque: 150.1 N·m(110.8 lbf-ft)

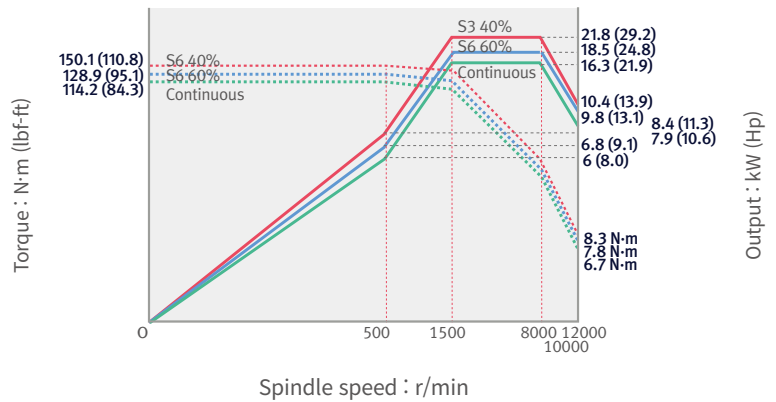

DNM 4500 / 5700 / 6700

15000 r/min

Max. spindle power: 16.5 kW (22.1 Hp)

Max. spindle torque: 141.3 N·m (104.3 lbf-ft)

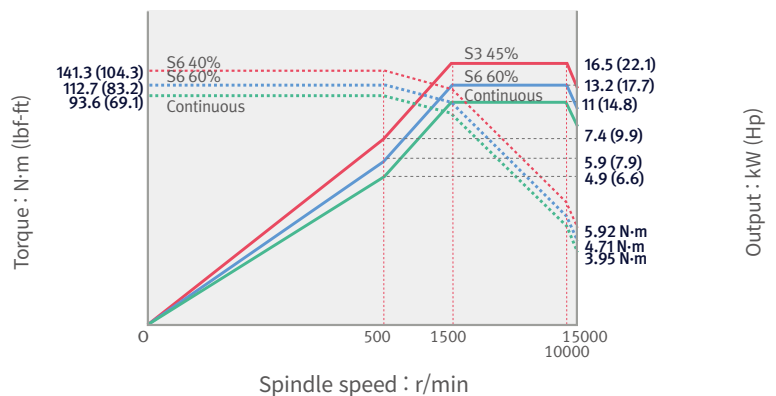

POWER | TORQUE

HEIDENHAIN | MITSUBISHI

HEIDENHAIN DNM 4500 / 5700

12000 r/min

Max. spindle power: 17 kW (22.8 Hp)

Max. spindle torque: 108.2 N·m (79.9 lbf-ft)

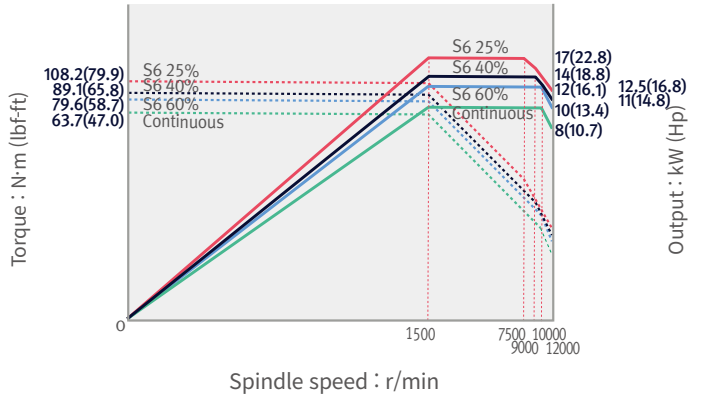

HEIDENHAIN DNM 6700

12000 r/min

Max. spindle power: 32 kW (42.9 Hp)

Max. spindle torque: 203.7 N·m (150.2 lbf-ft)

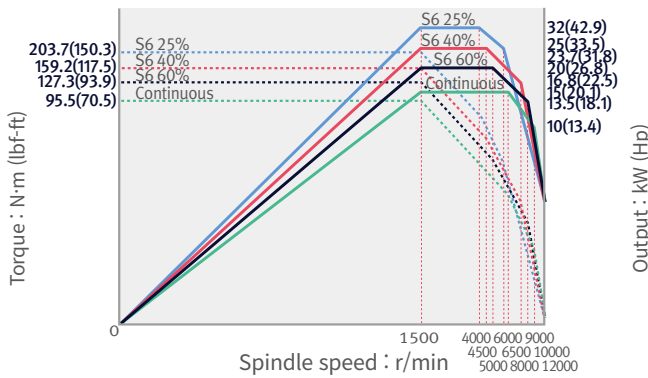

15000 r/min option

Max. spindle power: 17 kW (22.8 Hp)

Max. spindle torque: 108.2 N·m (79.9 lbf-ft)

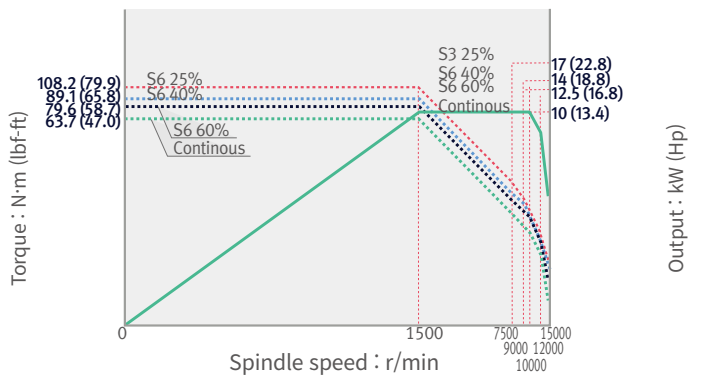

MITSUBISHI DNM 4500 / 5700 / 6700

12000 r/min option

Max. spindle power: 18.5 kW (24.8 Hp)

Max. spindle torque: 117.8 N·m (86.9 lbf-ft)

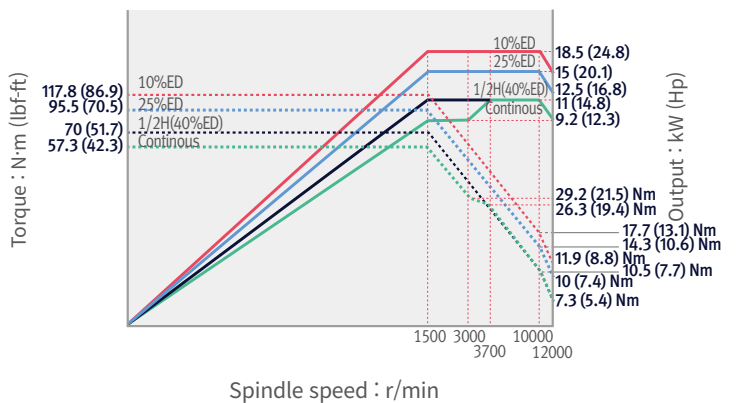

DIMENSIONS

DNM 4500

TOP

Units : mm (inch)

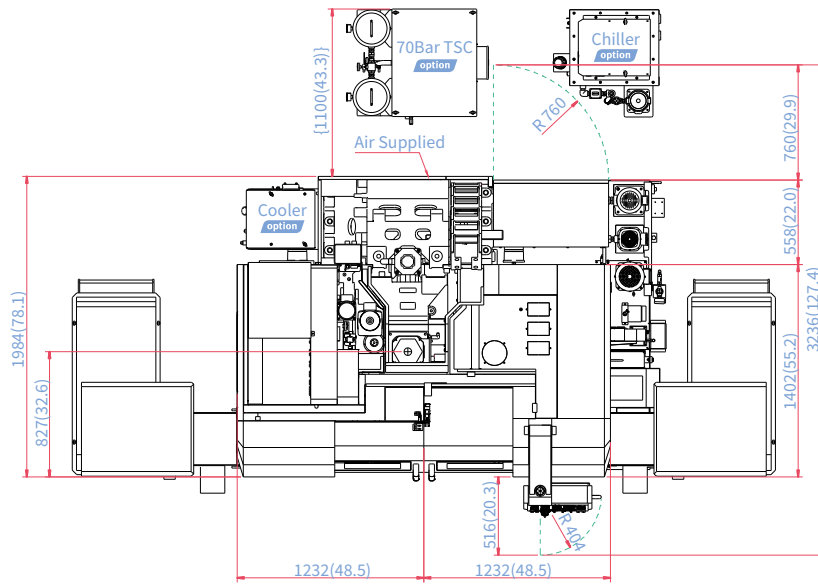

FRONT

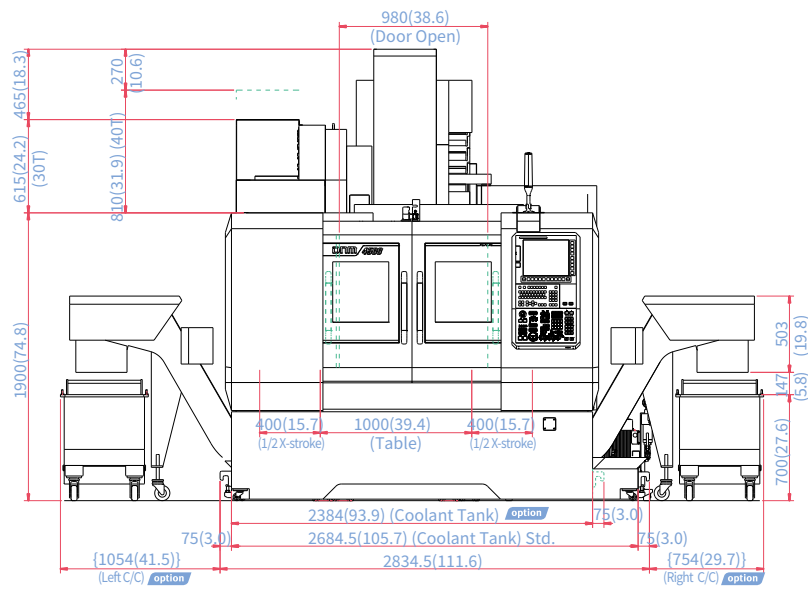

* If you want a coolant tank that is the same size as your machine, please contact our sales team.

SIDE

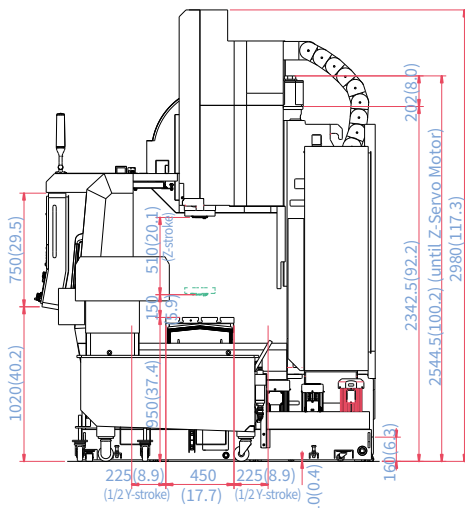

Table

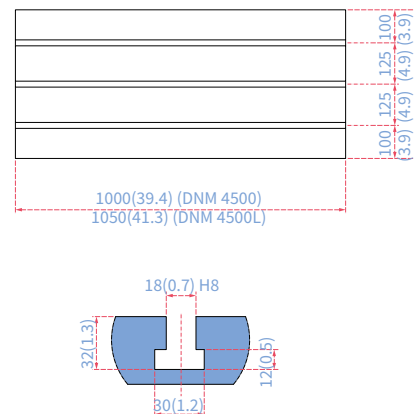

* Some peripheral equipment can be placed in other places *Rear chipconveyor need discuss with sales person

DIMENSIONS

DNM 6700

TOP

Units : mm (inch)

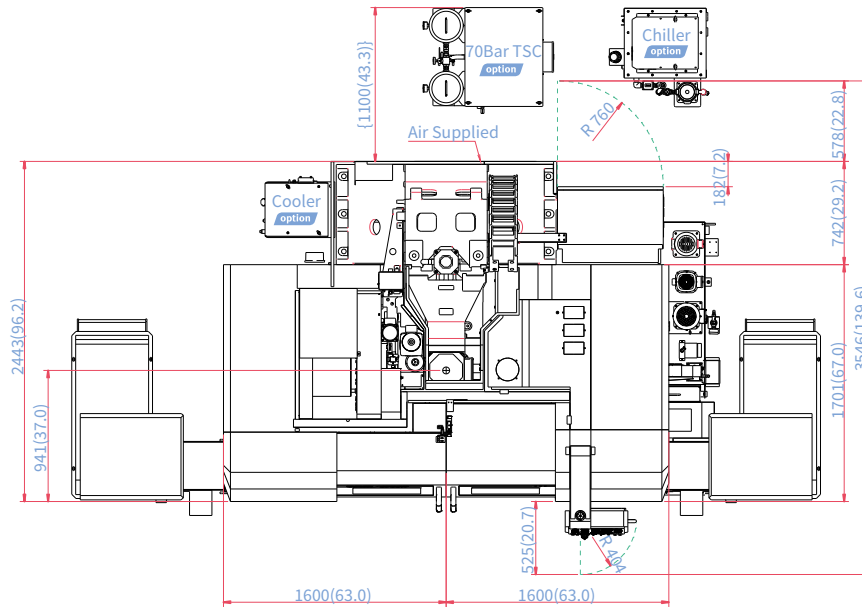

FRONT

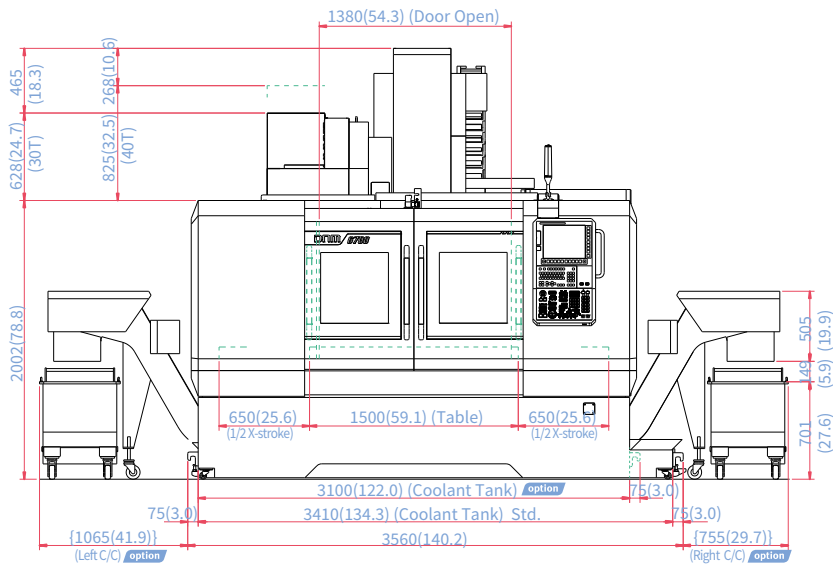

SIDE

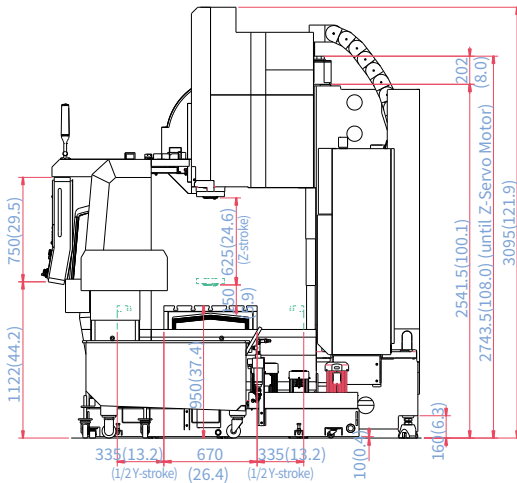

Table

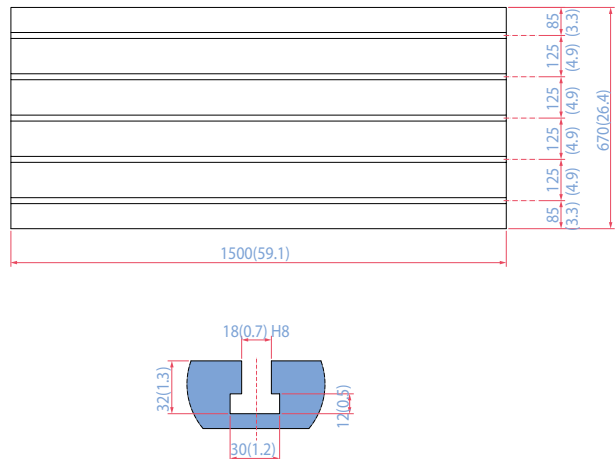

* Some peripheral equipment can be placed in other places *Rear chipconveyor need discuss with sales person

MACHINE SPECIFICATIONS

Description		Unit	DNM 4500	DNM 5700	DNM 6700	
Travels	Travel distance	X axis	mm (inch)	800 (31.5)	1050 (41.3)	1300 (51.2)
		Y axis	mm (inch)	450 (17.7)	570 (22.4)	670 (26.4)
		Z axis	mm (inch)	510 (20.1)		625 (24.6)
	Distance from spindle nose to table top		mm (inch)	150~660 (5.9~26.0)		150~775 (5.9~30.5)
Table	Table size		mm (inch)	1000 x 450 (39.4 x 17.7)	1300 x 570 (51.2 x 22.4)	1500 x 670 (59.1 x 26.4)
	Table loading capacity		kg (lb)	600 (1322.8)	1000 (2204.6)	1300 (2866.0)
	Table surface type		mm (inch)	T-SLOT (3-125(4.9) x 18(0.7)H8)	T-SLOT (4-125(4.9) x 18(0.7)H8)	T-SLOT (5-125(4.9) x 18(0.7)H8)
Spindle	Max. spindle speed		r/min	8000 {8000*, 12000, 15000}		
	Tool taper		-	ISO #40		
	Max. Spindle power (S3/Cont.)		kW (Hp)	18.5/11 (24.8/14.8) {15/11 (20.1/14.8)*, 18.5/11 (24.8/14.8), 18.5/11 (24.8/14.8)}		18.5/15 (24.8/20.1) {15/11 (20.1/14.8)*, 18.5/11 (24.8/14.8), 18.5/11 (24.8/14.8)}
	Max. spindle torque		N · m (lbf-ft)	117.8 (86.9) {286 (211.1)*, 117.8 (86.9), 117.8 (86.9)}		
Feedrates	Rapid traverse rate	X axis	m/min (ipm)	42 (1653.5)		36 (1417.3)
		Y axis	m/min (ipm)	42 (1653.5)		36 (1417.3)
		Z axis	m/min (ipm)	36 (1417.3)		30 (1181.1)
Automatic Tool Changer	Type of tool shank	Tool shank	-	BT 40 {CAT 40 / DIN 40}*		
		Pull stud	-	PS806 {Modified DIN / DIN 69872 #40}*		
	Tool storage capa.		ea	30{40} / 60 : SQ		
	Max. tool diameter	Continuous	mm (inch)	80 {76}		
		Without Adjacent Tools	mm (inch)	125 (4.9)		
	Max. tool length		mm (inch)	300 (11.8)		
	Max. tool weight		kg (lb)	8 (17.6)		
	Max. tool moment		N · m (ft-lbs)	5.88 (4.3)		
	Tool selection			MEMORY RANDOM		
	Tool change time (Tool-to-tool)		sec	1.2		
	Tool change time (Chip-to-chip)		sec	4.1(w/ Shutter) 3.2(w/o Shutter)		4.4(w/ Shutter) 3.5(w/o Shutter)
Power source	Electric power supply (rated capacity)		kVA	34.31		38.23
	Compressed air supply		MPa (psi)	0.54 (78.3)		
Tank capacity	Coolant tank capacity		L (gal)	380 (100.4)	430 (113.6)	485 (128.1)
Machine Dimensions	Height		mm (inch)	2980 (117.3)		3095 (121.9)
	Length		mm (inch)	2200 (86.6)	2470 (97.2)	2670 (105.1)
	Width		mm (inch)	2835 (111.6)	3320 (130.7)	3560 (140.2)
	Weight		kg (lb)	5000 (11023.0)	6500 (14329.8)	8500 (18739.0)
Control	NC system		-	DN Solutions Fanuc i Plus / SIEMENS S828D / HEIDENHAIN TNC620		

RESPONDING TO CUSTOMERS ANYTIME, ANYWHERE

DN Solutions Global Network

DN Solutions provides systems-based professional support services, before and after the machine tool sale, by responding quickly and efficiently to customers. By supplying spare parts, product training, field service and technical support, we provide the expert care, attention and assistance our customers expect from a market leader.

Global sales and service support network		51	Technical centers Technical center, Sales support, Service support, Parts support
4	Corporations	200	Service posts
155	Dealer networks	3	Factories



CUSTOMER SUPPORT AND SERVICES

We're there for you whenever you need us.

We help our customers operate at maximum efficiency by providing them with a range of tried, tested and trusted services - from pre-sales consultancy to post-sales support.



Field services

- On-site service
- Machine installation and testing
- Scheduled preventive maintenance
- Machine repair service



Parts supply

- Supplying a wide range of original DN Solutions spare parts
- Parts repair service



Training

- Programming, machine setup and operation
- Electrical and mechanical maintenance
- Applications engineering



Technical support

- Supports machining methods and technology
- Responds to technical queries
- Provides technical consultancy



dn-solutions.com

Head Office

19F, 10, Tongil-ro, Jung-gu
Seoul, Republic of Korea, 04527
Tel: +82-2-6972-0370/0350
Fax: +82-2-6972-0400

DN Solutions America

19A Chapin Road, Pine Brook
New Jersey 07058, United States
Tel: +1-973-618-2500
Fax: +1-973-618-2501

DN Solutions Europe

Emdener Strasse 24, D-41540
Dormagen, Germany
Tel: +49-2133-5067-100
Fax: +49-2133-5067-111

DN Solutions India

No.82, Jakkuar Village
Yelahanka Hobli, Bangalore-560064
Tel: + 91-80-2205-6900
E-mail: india@dncompany.com

DN Solutions China

Room 101,201,301, Building 39 Xinzhuan
Highway No.258 Songjiang District
China Shanghai (201612)
Tel: +86 21-5445-1155
Fax: +86 21-6405-1472

Sales inquiry

sales@dncompany.com

* For more details, please contact DN Solutions.

* Specifications and information contained within this catalogue may be changed without prior notice.