



HIGH PRECISION DIE & MOLD VERTICAL MACHINING CENTER

# DVM II

500II • 650II



**DN SOLUTIONS**

# DVM II SERIES

---

DVM II series seeks to make the spindle harder and last longer than the preceding DVM II series by opting for a static pressure spindle. The door width has been expanded to 2-door to make product installation more convenient. Furthermore, the quality of machining has been improved by standardizing the nut cooling ball screws of each spindle and the heat-shielding insulation in the columns in order to minimize heat displacement.





### HIGH RIGIDITY, HIGH PRECISION BUILT-IN SPINDLE

For the rigidity and extended life of the spindle, hydrostatic spindle has been adopted.

### INCREASED USER CONVENIENCE

With 2 Door System and expanded door width, workpiece mounting becomes more convenient.

### HIGHLY RIGID MACHINE STRUCTURE WITH EXCELLENT CUTTING PERFORMANCE

Ball screw nut cooling feature has been applied to all axes (X/Y/Z) to decrease 47% of heat displacement and thermal shielding insulation helps minimize heat deflection.

# BASIC STRUCTURE

The high rigidity structure of DVM II series has raised the static rigidity up by 30% more than previous model.

## High rigidity design

To minimize the bearing and motor heat a high-precision oil cooler controls the temperature to 0.1 degree.

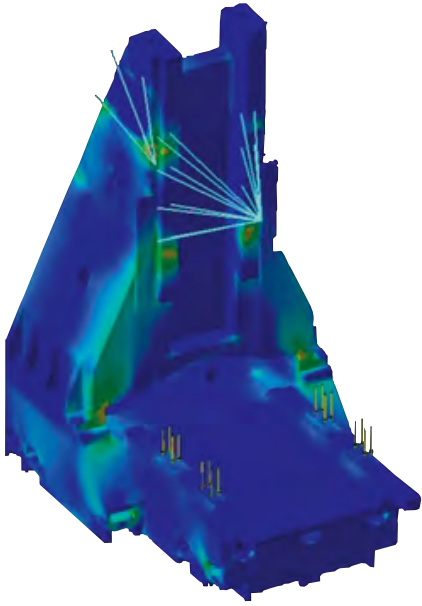

## Static rigidity

The high rigidity structure of DVM II has raised the static rigidity up by 30% more than previous model with no weak point through FEM\* analysis.

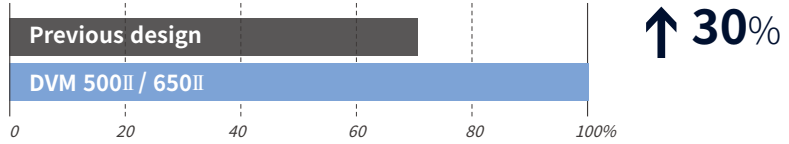

## Dynamic rigidity

Improving the frequency response and the damping ability of vibration makes it possible to increase the eigenfrequency 35% up on the previous model.

\* FEM : Finite Element Method

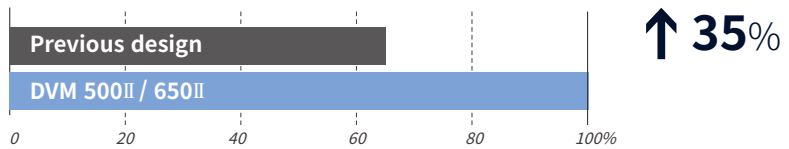

## High strength feed drive

### Ball screw nut cooling

Feed axis thermal displacement largely reduced Feed drive strength maintained in stable condition.

### Improvement of machining quality

Using nut cooling ball screws on every spindle (X, Y, and Z) reduces heat displacement by up to 47% compared with previous models

## Thermal displacement reduction

47 %

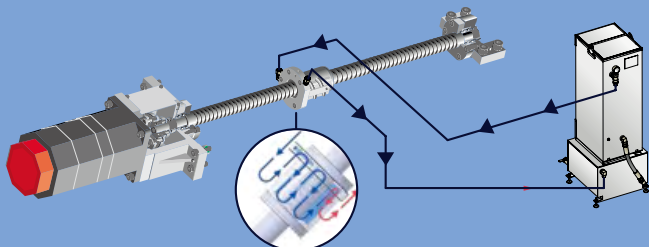

## Roller guide applied



## Rigid coupling

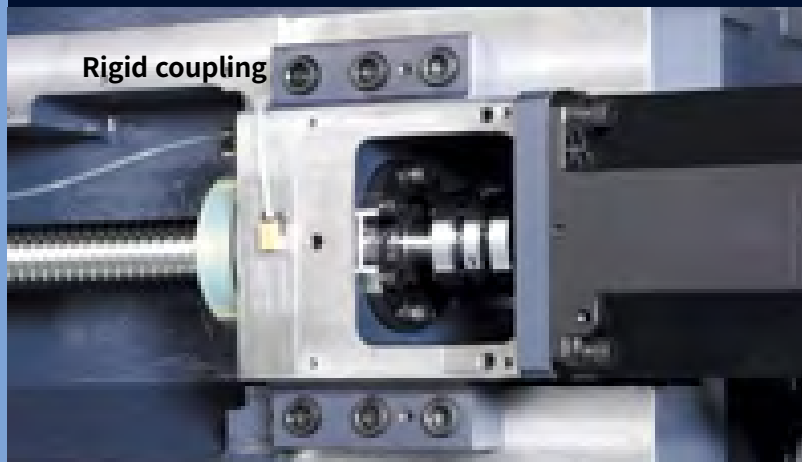

# SPINDLE

High speed and high precision built-in spindle ensures maintaining stable precision level while spindle head cooling system minimizes the heat deflection.

## Spindle vibration is minimized by shortening its length and optimization bearing pre-tension

### Spindle length

Improving productivity (high speed at rough machining, high precision at finish machining)

### Spindle length

**80 % ↓**

## 0.1 degree spindle head cooling system

To minimize the bearing and motor heat a high-precision oil cooler controls the temperature to 0.1 degree.

## Oil air lubrication

A optimal amount lubrication oil is applied by high pressure air to the bearings.

## 2-Face locking tool system (BBT40)

BT40 tool & 2-Face locking tool system(BIG PLUS) applied as standard.

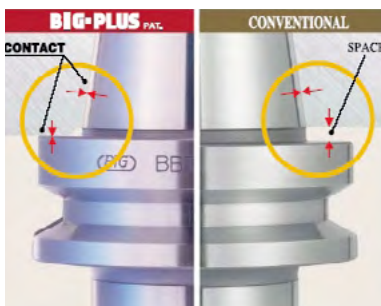

## Low vibration spindle

High precision balance and short spindle length  
by **40% less** than the previous model

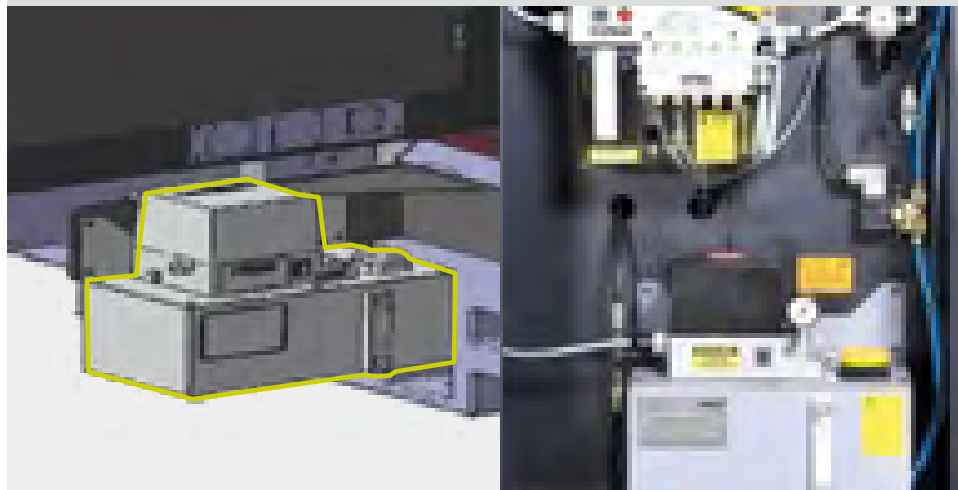
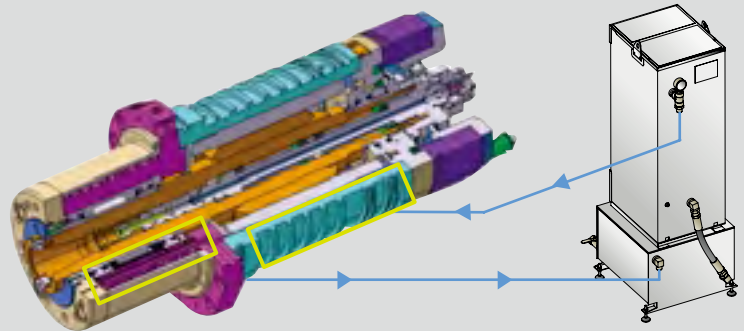
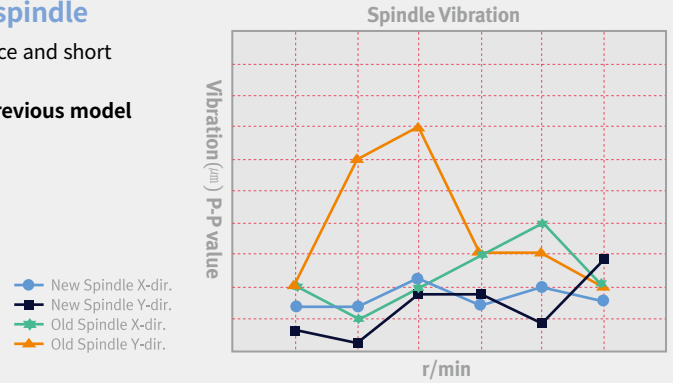

**Increases capacity of lubricating unit to reduce frequency of replacing lubricant**

DVM 500II/650II

**4.3 L ↑**

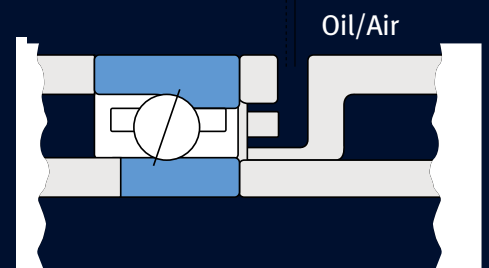

# THERMAL DISPLACEMENT COMPENSATION

Thermal displacement of the spindle is minimized, so processing accuracy can be maintained for even long periods of use. Automatic tool measurement device and High-performance oil-cooler as standard.

## Spindle static displacement compensation

To compensation displacement of tool by thermal deformation of spindle at high RPM. \*DHC: DN Solutions Heat Control

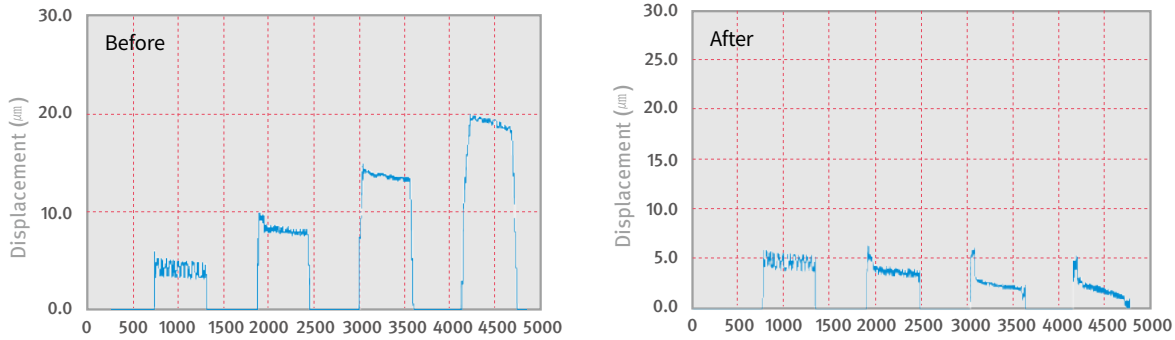

## Thermal displacement compensation

Thermal error of the spindle is calculated with the spindle temperature feedback and automatically compensated to maintain the highest level of work accuracy.

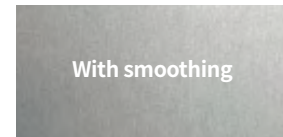
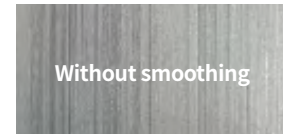
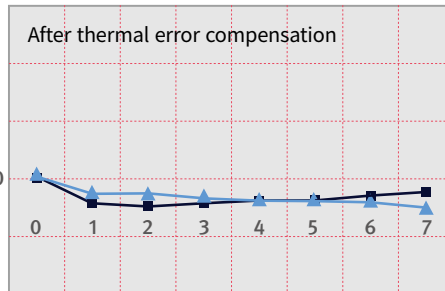
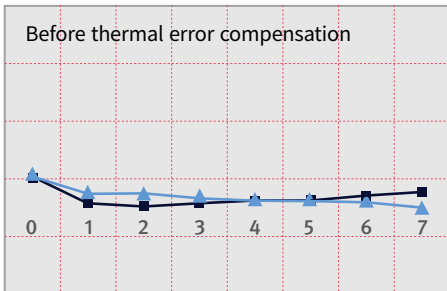

Thermal displacement compensation is achieved with 5 algorithm including smoothing function.

# HIGH SPEED | PRECISION CONTOUR CONTROL

Smooths the movement of the machine, improving surface roughness and profile accuracy of corners and edges.

- DSQ1 (Look ahead 200 block + Machining condition selection function)
- DSQ2 (DSQ1 + Data server [1GB]) OPTION
- DSQ3 (DSQ2 + High Speed Processing) OPTION
- \* DSQ : DN Solutions Super Quality

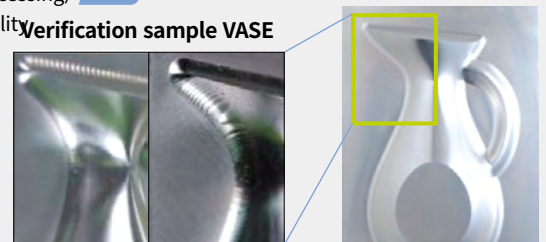

DSQ applied DSQ not applied

## Cutting condition selection function

Cutting condition	R1	R2	R3	R4	R5	R6	R7	R8	R9	R10
Quality	Normal									Excellent
Tool life	Long									Normal
Application	High-speed roughing							High-precision finishing		

- Use the R code in the program to change the cutting condition by up to 10 steps.
  - Improved productivity (high-speed roughing, high-precision finishing)
- Various servo-related NC parameters such as acceleration and deceleration time constants and maximum cutting feed can be set automatically.

# HIGH PRECISION | HIGH PRODUCTIVITY

DVM II series realizes high quality mold technology with high precision spindle run-out and highly rigid axis travel system.

## High precision spindle run-out and highly rigid axis traverse system

ø 0.2 mm micro feed needle machining : Needle machining is achieved by minimum spindle run-out and low vibration micro feed using a highly rigid axis traverse system.

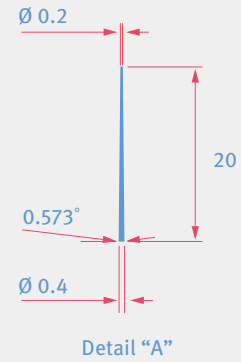

## High precision micro feed / surface roughness

### Work sample

Variation of offset value of workpiece height is less than 0.5µm

\* The results, indicated in this catalogue are provides as example. They may not be obtained due todifferences in cutting conditions and environmental conditions during measurement.

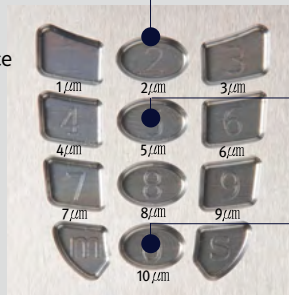

Depth : 2 µm



Depth : 5 µm



Depth : 10 µm

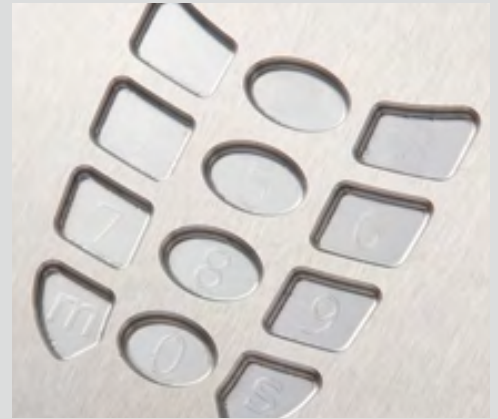

## The comparison of cycle time (actual result)

### A competitor's machine

**44 hr 44 min**



DVM 500II

**44 hr 44 min**

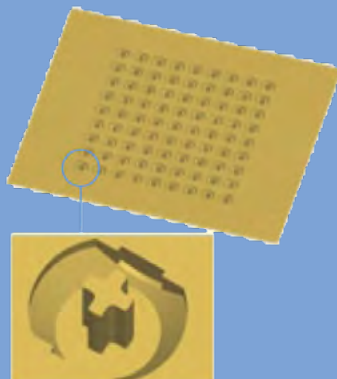

## VASE (Verification sample) cycle time

### A competitor's machine

**22 min 44 s**



DVM 500II

**21 min 32 s**

Interpolation of XYZ-axis



# STANDARD | OPTIONAL SPECIFICATIONS

Diverse optional features are available for customer-specific work applications.

Division	Item	Specifications	DVM 500II	DVM 650II
Spindle	20000 r/min	22/11 KW, 60.0 N·m	●	●
Magazine	Tool storage capacity	30ea	●	●
		40ea	○	○
Tool shank type	MAS403 BT 40		●	●
	CAT 40		○	○
	DIN 69871-A40		○	○
Coolant	FLOOD	0.19 MPa(0.4kW)	●	●
		0.69 MPa(1.8kW)	○	○
	TSC	None	●	●
		2MPa(1.5kW)	○	○
		2MPa(1.5kW)	○	○
		7MPa(5.5kW)	○	○
		Shower Coolant	○	○
Chip disposal options	Chip conveyor	Chip pan	○	○
		Hinged type(side)	○	○
	Chip bucket	Forklift type	○	○
		Rotary type	○	○
	Air blower		●	●
	Air gun		○	○
	Coolant Gun		○	○
Precision machining option	Linear scale	X/Y/Z	○	○
	DSQ1 (200 block)		●	●
	DSQ2 (DSQ 1, DATA SERVER 1G)		○	○
	DSQ3 (DSQ 2, 600 block)		○	○
	DSQ4 (DSQ 3, 1000 block)		○	○
Measuring & automation	Automatic tool measurement	TS27R_RENISHAW	●	●
		NC4_RENISHAW	○	○
	Automatic tool breackage detection		○	○
	Automatic workpiece measurement	OMP60_RENISHAW	○	○
Customized Special Option	DRUM CHIPCONVEYOR	HINGE TYPE	○	○
		SCRAPER TYPE	○	○
	GRAPHITE PACKAGE	BELLOWS COVER	○	○
		TABLE SUB COVER	○	○
		ATC FULL COVER	○	○
		BALLSCREW COVER	○	○
	LUBRICATION	GREASE TYPE	○	○
	OIL RECOVERY DEVICE	SPINDLE BEARING OIL RECOVERY DEVICE	○	○
	ANCHORING	SLIDE CLAMP & CHEMICAL ANCHOR BOLT	○	○
	COOLANT CHILLER		○	○
	TSA MAX PRESSURE 0.54 MPa		○	○

Please contact your DN Solutions representative for detailed machine information.

● Standard ○ Optional X N/A



There is a high risk of fire when using non-water-soluble cutting fluids, processing flammable materials, neglecting the controlled and careful use of coolants and modifying the machine without the consent of the manufacturer. Always check the SAFETY GUIDELINES carefully before using the machine.



# PERIPHERAL EQUIPMENT

## Interface for additional equipment OPTION

### Connection example of additional 4 axis interface, fixture interface

\* Recommended rotary table : Ø250(DVM 500 II) , Ø320(DVM 650 II)

\* Please check your rotary table's drive system (hydraulic/ pneumatic) before purchasing the equipment. 유압 구동 ATC 및 서보모터 구동 메거진은 높은 신뢰성을 보유하며 장비 비가동시간을 최소화 합니다.

### Air blower

건식가공 및 쉬운 MQL 연결

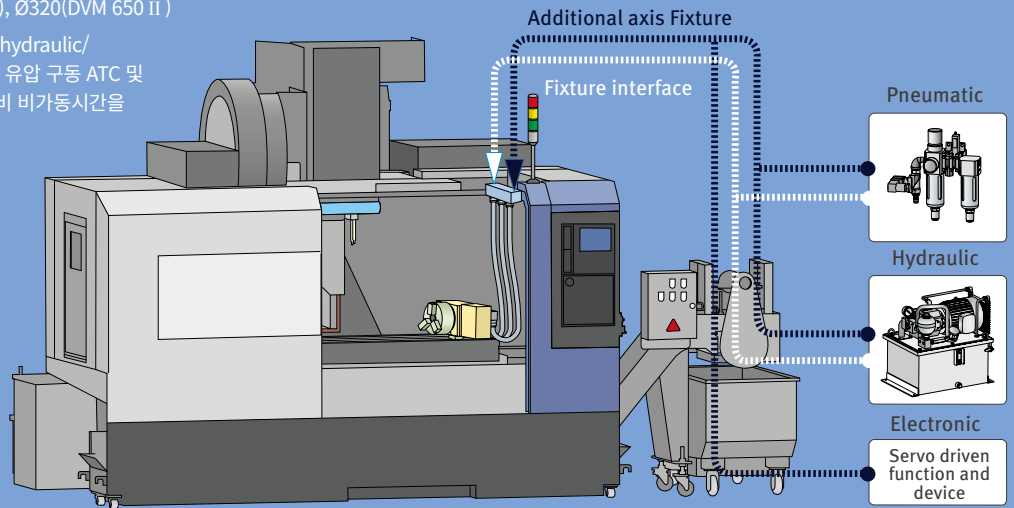

### Through spindle coolant(TSC) Oil skimmer



### Coolant gun



### Automatic tool measurement

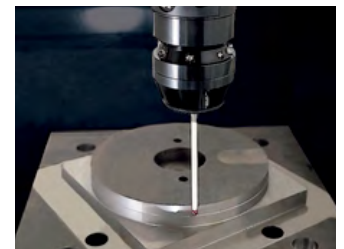

### Additional axis interface

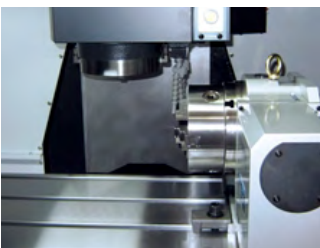

### Rear chip conveyor

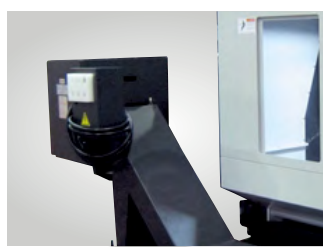

### Automatic tool breakage detection



### Auto tool measurement device (TS27R)



### Coolant chiller (recommended) OPTION

### Automatic front door

### MQL (Minimum quantity lubrication)

A coolant chiller is recommended to help prevent temperature rises and to reduce thermal deformation when using a water-insoluble coolant or high-pressure coolant system (i.e., power over 1.5kW).

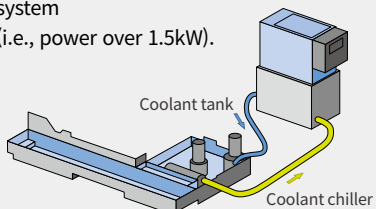

# PERIPHERAL EQUIPMENT

## Chip disposal

Management of chips from the viewpoint of productivity improvement and environmental countermeasure is important. DVM II series offer a variety of chip control equipment to provide enhanced accuracy and better chip removal capabilities.

## Easy chip disposal structure

The completely enclosed DVM II series guarantee the confinement of chips and coolant to the inside of the machining area. Chips fall into the removable forward mounted chip pan for easy disposal.

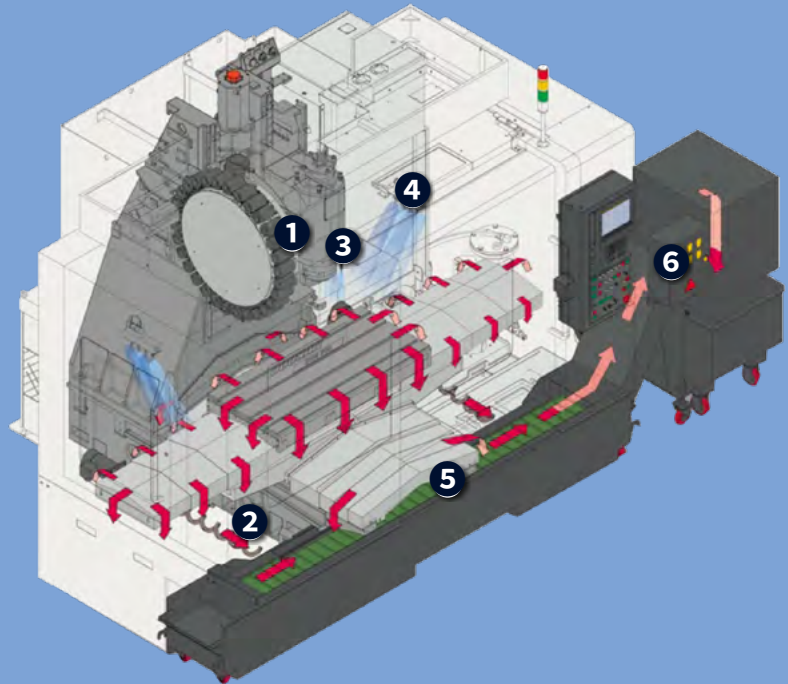

### 1. Oil/Water separation structure

Middle pressure : 1.96 Mpa [20 bar]  
High pressure : 6.86 Mpa [70 bar]

\* The pump's discharge outlet. The pressure at the tip of the tool can be decreased by 20-30 %.

OPTION



### 4. Shower coolant OPTION



### 2. Screw conveyor



### 5. Large capacity coolant tank Large capacity coolant tank

Easy to discard chips piled up

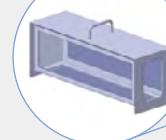

Coolant tank capacity 380L

### 3. Flood coolant pump



### 6. Chip conveyor OPTION

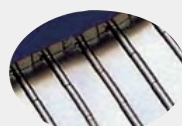

Hinge type



Scraper type



Drum filter type

# PERIPHERAL EQUIPMENT

## Operators panel



### 1. Swivelling Operating console

An easy-to-use operation panel which can swivel from 0-90°

### 2. ATC operating button is arranged to main panel

This can give much easier operation and maintenance for ATC.

Magazine : CW

Magazine : CCW



### 3. Portable MPG

Portable MPG makes a workpiece setting easier for the operator



## 2-Door

Top cover can be opened to provide easy access for loading heavy workpieces to the center of the table.



## Brighter working area

Fluorescent lamps for safety and clear view of the working area.

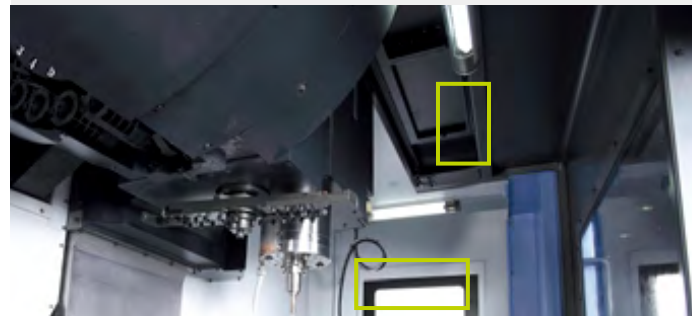

## Separates cutting fluid from wasted oil in coolant tank

It prolongs the use of cutting fluid and also enhances productivity. As an optional feature, oil skimmer can be attached for better efficiency.

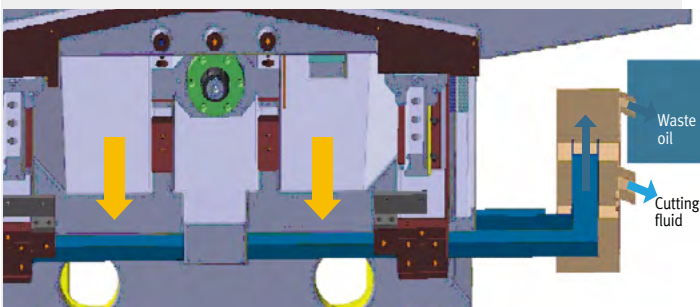

## Air port

Air port is provided as a standard feature. ( Air Gun : **OPTION** )

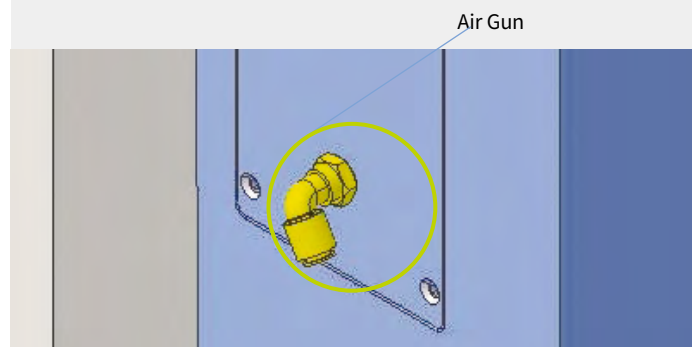

# FANUC 31i/32i PLUS

Fanuc 31i/32i Plus maximizes customer productivity and convenience.

## 15" Touch screen + New OP

DN Solutions Fanuc 31iB/B5 Plus' operation panel enhances operating convenience by incorporating common-design buttons and layout. It features a Qwerty keyboard for fast and easy data input and operation.

### Fanuc 31i/32i Plus

- 15-inch color display
- Intuitive and user-friendly design

### USB and PCMCIA card QWERTY keyboard

- EZ-Guide i standard
- Ergonomic operator panel
- 4MB Memory
- Hot keys
- Enhance AICC BLOCK
- Touch pen provided as standard



### iHMI touchscreen

iHMI provides an intuitive interface that uses a touchscreen for quick and easy operation.

### Range of applications

Providing various applications related to planning, machining, improvement and utility, for customer convenience.

## NUMERIC CONTROL SPECIFICATIONS

FANUC

Division	Item	Specifications	DVM 500 II / 650 II
			F31iB Plus
Controlled axis	Controlled axes		5 (X,Y,Z)
	Simultaneously controlled axes		5 axes
	Additional controlled Axis	Add 1 Axis (5th Axis)	●
Data input/output	Fast data server		○
	Memory card input/output		●
	USB memory input/output		●
	Large capacity memory(2GB)*2	Available Option only with 15" Touch LCD (iHMI Only) *2)	○
Interface function	Embedded Ethernet		●
	Fast Ethernet		○
	Enhanced Embedded Ethernet function		●
Operation	DNC operation	Included in RS232C interface.	●
	DNC operation with memory card		●
	Workpiece coordinate system	G52 - G59	●
Program input	Addition of workpiece coordinate system	G54.1 P1 X 48 (48 pairs)	●
	Tool number command		●
	Tilted working plane indexing command	G68.2 TWP	●
Feed function	AI contour control I	G5.1 Q_ , 40 Blocks	X
	AI contour control II	G5.1 Q_ , 200 Blocks	X
	AI contour control II	G5.1 Q_ , 600 Blocks	X
	AI contour control II	G5.1 Q_ , 1000 Blocks *1)	●
	High smooth TCP		X
Operation Guidance Function	EZ Guidei (Conversational Programming Solution)		●
	iHMI with Machining Cycle	Only with 15" Touch LCD standard *2)	X
	EZ Operation package		●
Setting and display	CNC screen dual display function		●
Network	FANUC MTConnect		*
	FANUC OPC UA		*
Others	Part program storage size & Number of registerable programs	10.4" color LCD	X
		15" color LCD	X
		15" color LCD with Touch Panel	●
		640M(256KB)_ 500 programs	X
		1280M(512KB)_ 1000 programs	○
		2560M(1MB)_ 1000 programs	○
		5120M(2MB)_ 1000 programs	○
		10240M(4MB)_ 1000 programs	●
		20480M(8MB)_ 1000 programs	○
		2560M(1MB)_ 2000 programs	○
		5120M(2MB)_ 4000 programs	○
		10240M(4MB)_ 4000 programs	○
		20480M(8MB)_ 4000 programs	○

● Standard ○ Optional X N/A \* Available

# EZ WORK

## F31iB Plus

### EZ WORK

Setting up of tools, work pieces and programs, as well as troubleshooting for abnormal condition of main parts, is designed to minimize waiting time, maximize operational efficiency, and enhance operator convenience.



#### Thermal compensation

A function to maintain high-precision machining quality by analyzing and correcting the amount of thermal displacement of a structure through a temperature sensor



#### M/G-Code List

Functional description of M code and G code



#### Tool Management

Function to manage tool information [Tool information / Tool No. / Tool condition (normal, large diameter, worn / damaged, used for the rst time, manual) / Tool name]

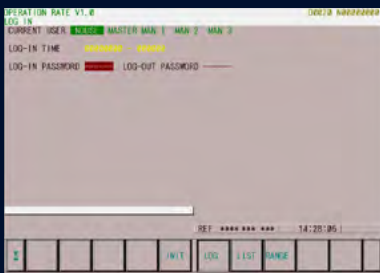

#### Operation Rate

Machine operation history management function by date based on load



#### Adaptive Feed Control

Function to control feedrate so that the cutting can be carried out at a constant load



#### Spindle Warm Up

A function that assists spindle warm-up for spindle life when the spindle has not been used for a certain period of time



#### ATC Recovery

Function to view detailed info with recommended actions and to perform step-by-step operation manually (when an alarm is triggered during an ATC operation)

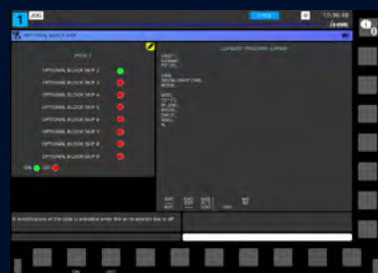

#### Addition of Optional Block Skip

In addition to the OPTIONAL BLOCK SKIP of the operation panel, the function to skip a specific block selected in the machining program

# POWER | TORQUE

## F31iB Plus

Max. spindle speed : **20000** r/min

Max. motor power : **22** kW  
29.5 Hp

Max. motor torque : **60** N·m  
44.3 ft-lbs

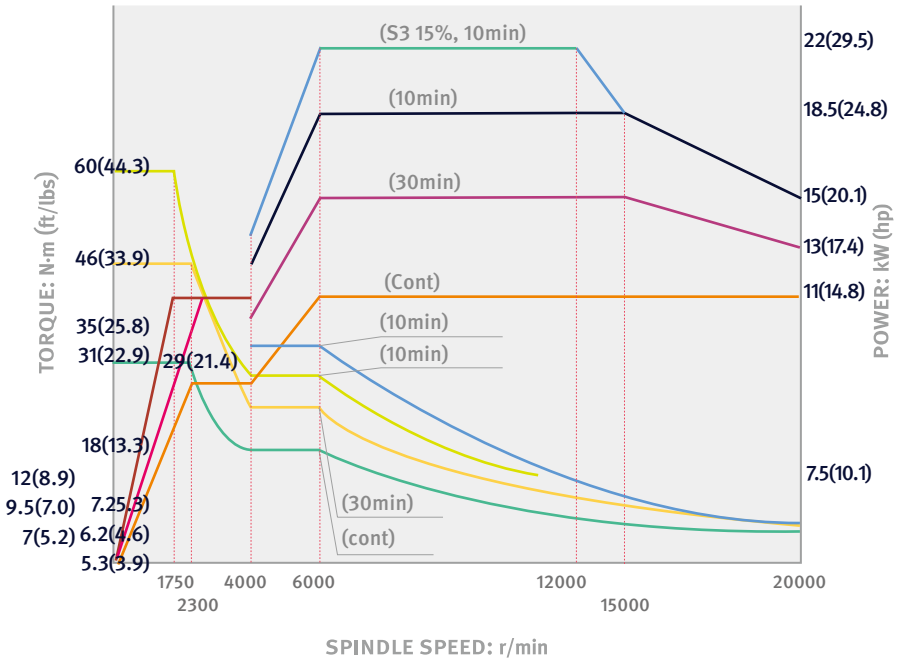

# TABLE DIMENSIONS

## DVM 500II

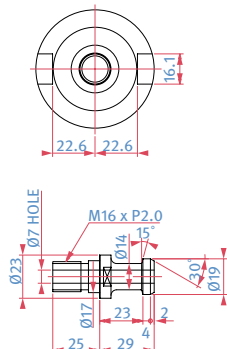
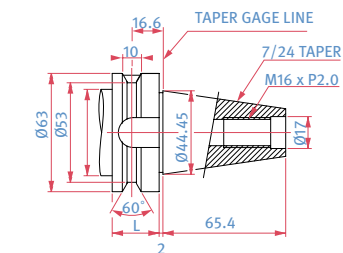
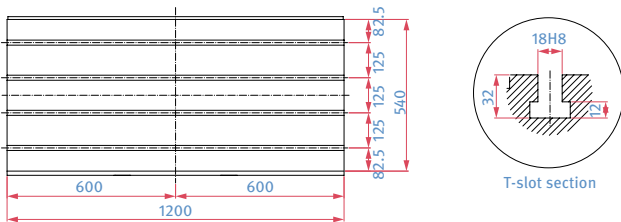

## DVM 650II

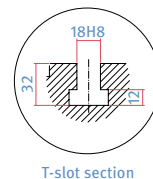
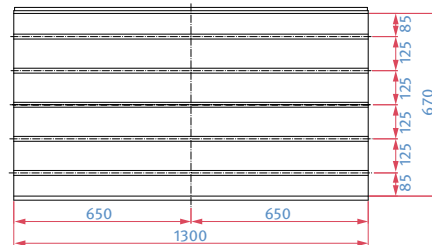

Tool shank type (MAS 403 BT 40)

\* Pull Stud's standard specification is 15°.  
PS BT40 M16 JIS B (by TaeguTec) or  
PS-806 (by NIKKEN)

# EXTERNAL DIMENSIONS

DVM 500II

Unit : mm (inch)

TOP

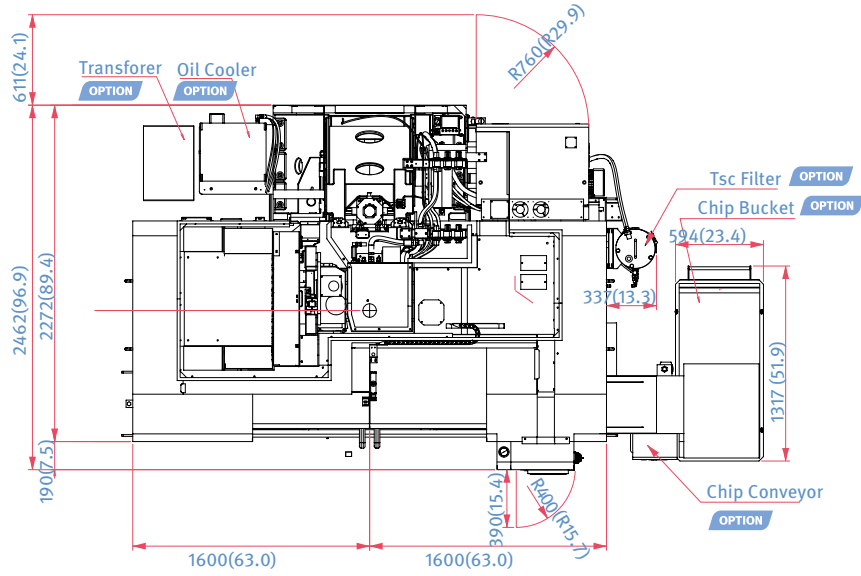

FRONT

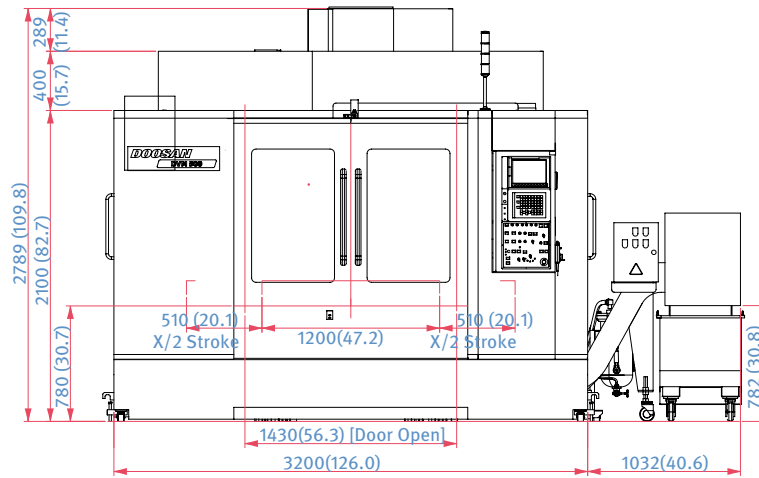

SIDE

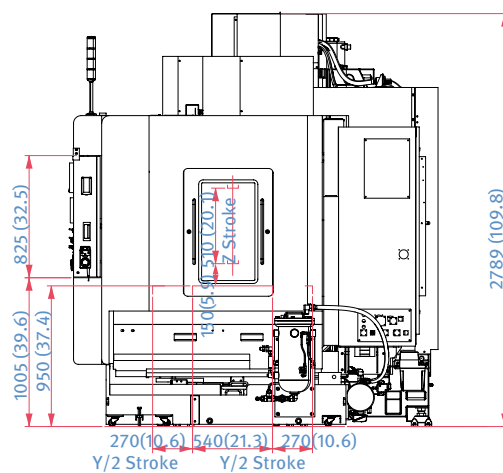

\* Some peripheral equipment can be placed in other areas.

# EXTERNAL DIMENSIONS

DVM 650II

Unit : mm (inch)

TOP

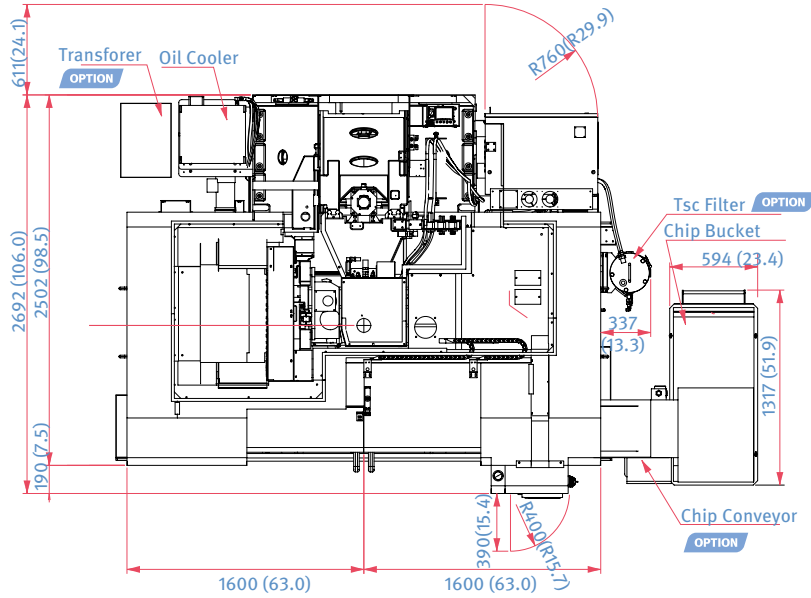

FRONT

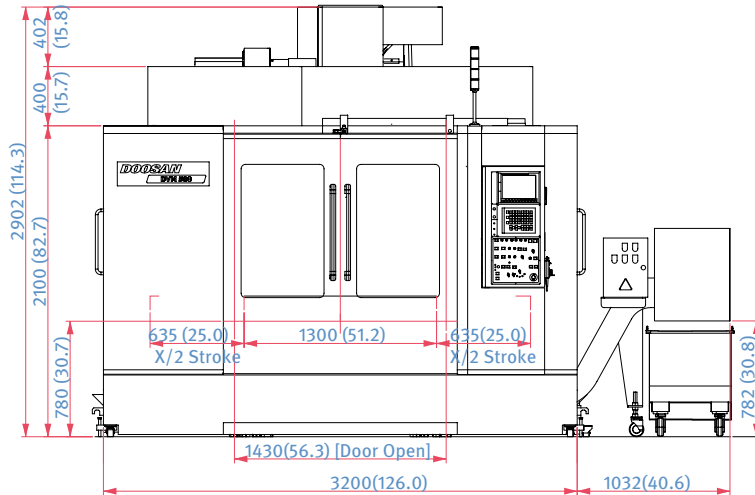

SIDE

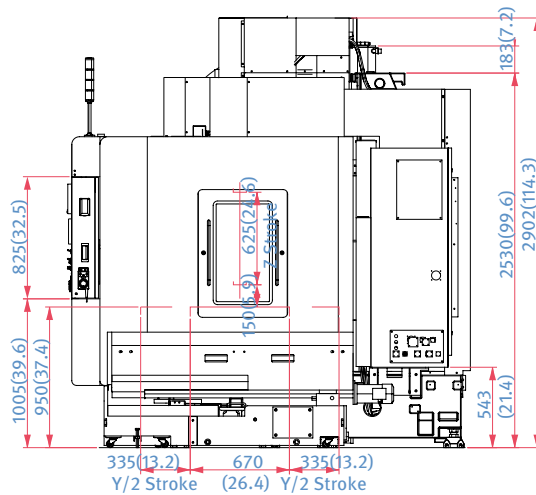



# MACHINE SPECIFICATIONS

Description		Unit	DVM 500 II	DVM 650 II
Travels	X axis	mm (inch)	1020 (40.2)	1270 (50.0)
	Y axis	mm (inch)	540 (21.3)	670 (26.4)
	Z axis	mm (inch)	510 (20.1)	625 (24.6)
	Distance from spindle nose to table top	mm (inch)	150 - 660 (5.9 - 26.0)	150 - 775 (5.9 - 30.5)
Feedrates	Rapid traverse rate (X / Y / Z)	m/min (ipm)	30 / 30 / 30 (1181.1 / 1181.1 / 1181.1)	
	Cutting feedrate	m/min (ipm)	1~15000 (1~590.6)	
Table	Table size	mm (inch)	1200 x 540 (47.2 x 21.3)	1300 x 670 (51.2 x 26.4)
	Table loading capacity	kg (lb)	800 (1763.7)	1000 (2204.6)
Spindle	Max. spindle speed	r/min	20000	
	Taper		ISO #40, 7/24 Taper	
	Max. spindle torque	N · m (ft-lbs)	60 (44.3)	
Automatic Tool Changer	Tool shank type		MAS403 BT40	
	Tool storage capa.	ea	30 {40}	
	Max. tool diameter	mm (inch)	80 / 125 {76 / 125} (3.2 / 4.9 {3.0 / 4.9})	
	Max. tool length	mm (inch)	300 (11.8)	
	Max. tool weight	kg (lb)	8 (17.6)	
	Max. tool moment	N · m (ft-lbs)	5.88 (4.3)	
	Tool selection		Memory random	
	Tool change time (Tool-to-tool)	s	1.3	
	Tool change time (Chip-to-chip)	s	3.7	
Motor	Spindle motor (Cont. / 30 min/ S3 15%)	kW (Hp)	11 / 15 / 22 (14.8 / 20.1 / 29.5)	
Tank capacity	Coolant tank capacity	L (gal)	380 (100.4)	
	Lubrication tank capacity	L (gal)	4.3 (1.1)	
Power Source	Electric power supply	kVA	44.6	
Machine dimensions	Height	mm (inch)	2789 (109.8)	2905 (114.4)
	Length x Width	mm (inch)	2462 x 3350 (96.9 x 131.9)	2692 x 3350 (106.0 x 131.9)
	Weight	kg (lb)	6500 (14329.8)	8500 (18739.0)

The DN Solutions promise, MACHINE GREATNESS, has two important meanings. The first is simple: DN Solutions makes great machines. The second is a challenge to our end-users. With a product line that is this comprehensive, accurate and reliable, we equip our customers to machine greatness. **The big question: *Why should you choose DN Solutions over other options?***

Here's why...

필드 서비스

## MACHINE GREATNESS™



WHAT YOU MAKE AND HOW YOU MAKE IT MATTERS—SO MAKE IT GREAT WITH DN SOLUTIONS.

### UNBEATABLE MACHINES

You won't find a more comprehensive range or a better combination of value, performance and reliability anywhere else.

### ROBUST PRODUCT LINE

We offer an impressive range of machine models and hundreds of configurations. Whatever your machining needs and requirements, there's a DN Solutions for you.

### READILY AVAILABLE - ANYWHERE IN THE WORLD

Machining centres (including 5-axis machines), lathes, multi-tasking turning centres and mill-turn machines, and horizontal borers with best-in-class specifications are all available...ready to install.

### EXPERT SERVICE

Our dedicated, experienced and knowledgeable team is totally committed to improving your productivity, growth and success.

# RESPONDING TO CUSTOMERS ANYTIME, ANYWHERE

## DN Solutions Global Network

DN Solutions provides systems-based professional support services, before and after the machine tool sale, by responding quickly and efficiently to customers. By supplying spare parts, product training, field service and technical support, we provide the expert care, attention and assistance our customers expect from a market leader.

Global sales and service support network		<b>51</b>	<b>Technical centers</b> Technical center, Sales support, Service support, Parts support
<b>4</b>	Corporations	<b>200</b>	<b>Service posts</b>
<b>156</b>	Dealer networks	<b>3</b>	<b>Factories</b>



## CUSTOMER SUPPORT AND SERVICES

**We're there for you whenever you need us.**

We help our customers operate at maximum efficiency by providing them with a range of tried, tested and trusted services - from pre-sales consultancy to post-sales support.



### Field services

- On-site service
- Machine installation and testing
- Scheduled preventive maintenance
- Machine repair service



### Parts supply

- Supplying a wide range of original DN Solutions spare parts
- Parts repair service



### Training

- Programming, machine setup and operation
- Electrical and mechanical maintenance
- Applications engineering



### Technical support

- Supports machining methods and technology
- Responds to technical queries
- Provides technical consultancy



[dn-solutions.com](http://dn-solutions.com)

**Head Office**

22F T Tower, 30, Sowol-ro 2-gil  
Jung-gu, Seoul, Korea, 04637

Tel: +82-2-6972-0370/0350  
Fax: +82-2-6972-0400

**DN Solutions America**

19A Chapin Road, Pine Brook  
New Jersey 07058, United States

Tel: +1-973-618-2500  
Fax: +1-973-618-2501

**DN Solutions Europe**

Emdener Strasse 24, D-41540  
Dormagen, Germany

Tel: +49-2133-5067-100  
Fax: +49-2133-5067-111

**DN Solutions India**

No.82, Jakkuar Village  
Yelahanka Hobli, Bangalore-560064

Tel: + 91-80-2205-6900  
E-mail: [india@dncompany.com](mailto:india@dncompany.com)

**DN Solutions China**

Room 101,201,301, Building 39 Xinzhuan  
Highway No.258 Songjiang District  
China Shanghai (201612)

Tel: +86 21-5445-1155  
Fax: +86 21-6405-1472

**Sales inquiry**

[sales@dncompany.com](mailto:sales@dncompany.com)

\* For more details, please contact DN Solutions.

\* Specifications and information contained within this catalogue may be changed without prior notice.